

# Multi-band F-Panel

## Dual Polarization

### Half-power Beam Width

### Adjust. Electrical Downtilt

set by hand or by optional RCU (Remote Control Unit)

1710–2200

X

65°

0°–10°

#### XPol F-Panel 1710–2200 65° 18dBi 0°–10°T

Type No.	742 215		
Frequency range	1710–2200		
	1710 – 1880 MHz	1850 – 1990 MHz	1920 – 2200 MHz
Polarization	+45°, –45°	+45°, –45°	+45°, –45°
Gain	2 x 17.7 dBi	2 x 17.9 dBi	2 x 18 dBi
Half-power beam width Copolar +45°/–45°	Horizontal: 67° Vertical: 6.8°	Horizontal: 66° Vertical: 6.5°	Horizontal: 65° Vertical: 6.2°
Electrical tilt continuously adjustable	0°–10°	0°–10°	0°–10°
Vertical Pattern – sidelobe suppression for first sidelobe above main beam	0° ... 4° ... 8° ... 10° T 18 ... 17 ... 17 ... 17 dB	0° ... 4° ... 8° ... 10° T 18 ... 18 ... 17 ... 17 dB	0° ... 4° ... 8° ... 10° T 18 ... 18 ... 17 ... 18 dB
Front-to-back ratio (180° ± 30°)	Copolar: > 30 dB Total power: > 25 dB	Copolar: > 30 dB Total power: > 25 dB	Copolar: > 30 dB Total power: > 25 dB
Cross polar ratio Maindirection 0° Sector ±60°	Typically: 25 dB > 10 dB	Typically: 25 dB > 10 dB	Typically: 25 dB > 10 dB
Isolation, between ports	> 30 dB	> 30 dB	> 30 dB
Impedance	50 Ω	50 Ω	50 Ω
VSWR	< 1.5	< 1.5	< 1.5
Intermodulation IM3 (2 x 43 dBm carrier)	< –150 dBc		
Max. power per input	300 W (at 50 °C ambient temperature)		



#### 1710 – 1880 MHz: +45°/–45° Polarization

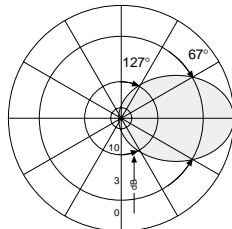

Horizontal Pattern

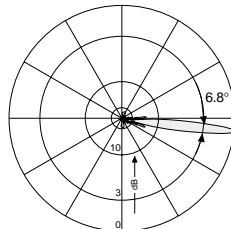

Vertical Pattern  
0°–10° electrical downtilt

#### 1850 – 1990 MHz: +45°/–45° Polarization

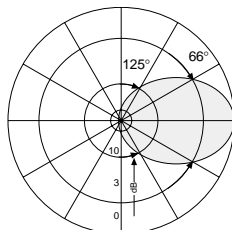

Horizontal Pattern

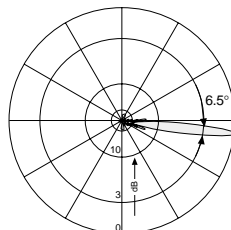

Vertical Pattern  
0°–10° electrical downtilt

#### 1920 – 2200 MHz: +45°/–45° Polarization

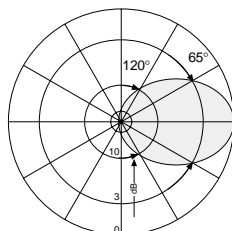

Horizontal Pattern

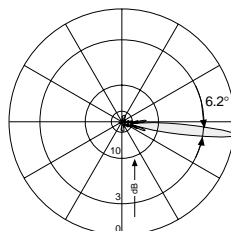

Vertical Pattern  
0°–10° electrical downtilt

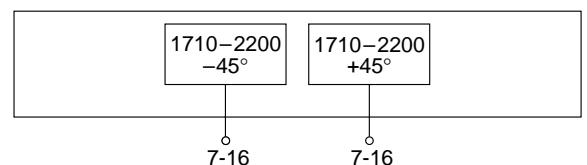

#### Mechanical specifications

Input	2 x 7-16 female
Connector position	Bottom
Adjustment mechanism	1x, Position bottom continuously adjustable
Weight	7.5 kg
Wind load	Frontal: 130 N (at 150 km/h) Lateral: 110 N (at 150 km/h) Rearside: 310 N (at 150 km/h)
Max. wind velocity	200 km/h
Packing size	1574 x 172 x 92 mm
Height/width/depth	1302 / 155 / 69 mm

### Accessories (order separately)

Type No.	Description	Remarks	Material	Weight approx.	Units per antenna
734 360	2 clamps	Mast: 34 – 60 mm dia.	Stainless steel	60 g	1
734 361	2 clamps	Mast: 60 – 80 mm dia.	Stainless steel	70 g	1
734 362	2 clamps	Mast: 80 – 100 mm dia.	Stainless steel	80 g	1
734 363	2 clamps	Mast: 100 – 120 mm dia.	Stainless steel	90 g	1
734 364	2 clamps	Mast: 120 – 140 mm dia.	Stainless steel	110 g	1
734 365	2 clamps	Mast: 45 – 125 mm dia.	Stainless steel	80 g	1
738 546	1 clamp	Mast: 50 – 115 mm dia.	Hot-dip galvanized steel	1.0 kg	2
850 10002	1 clamp	Mast: 110 – 220 mm dia.	Hot-dip galvanized steel	2.7 kg	2
850 10003	1 clamp	Mast: 210 – 380 mm dia.	Hot-dip galvanized steel	4.8 kg	2
732 317	1 downtilt kit	Downtilt angle: 0° – 10°	Stainless steel	1.0 kg	1

For downtilt mounting use the clamps for an appropriate mast diameter together with the downtilt kit.  
Wall mounting: No additional mounting kit needed.

#### Material:

**Reflector screen:** Tin plated copper. **Radiator:** Tin plated zinc.  
**Flat fiberglass radome:** The max. radome depth is only 69 mm. Fiberglass material guarantees optimum performance with regards to stability, stiffness, UV resistance and painting. The colour of the radome is grey.  
**All screws and nuts:** Stainless steel.

#### Grounding:

The metal parts of the antenna including the mounting kit and the inner conductors are DC grounded.

#### Environmental conditions:

Kathrein cellular antennas are designed to operate under the environmental conditions as described in ETS 300 019-1-4 class 4.1 E.  
The antennas exceed this standard with regard to the following items:  
– Low temperature: –55 °C  
– High temperature (dry): +60 °C

Ice protection: Due to the very sturdy antenna construction and the protection of the radiating system by the radome, the antenna remains operational even under icy conditions.

#### Environmental tests:

Kathrein antennas have passed environmental tests as recommended in ETS 300 019-2-4. The homogenous design of Kathrein's antenna families use identical modules and materials. Extensive tests have been performed on typical samples and modules.

#### Please note:

**As a result of more stringent legal regulations and judgements regarding product liability, we are obliged to point out certain risks that may arise when products are used under extraordinary operating conditions.**

The mechanical design is based on the environmental conditions as stipulated in ETS 300 019-1-4, which includes the static mechanical load imposed on an antenna by wind at maximum velocity. Extraordinary operating conditions, such as heavy icing or exceptional dynamic stress (e.g. strain caused by oscillating support structures), may result in the breakage of an antenna or even cause it to fall to the ground. These facts must be considered during the site planning process.

**The installation team must be properly qualified and also be familiar with the relevant national safety regulations.**

**The details given in our data sheets have to be followed carefully when installing the antennas and accessories.**

**The limits for the coupling torque of RF-connectors, recommended by the connector manufacturers must be obeyed.**

**Any previous datasheet issues have now become invalid.**

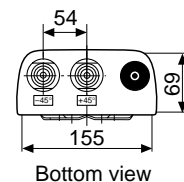
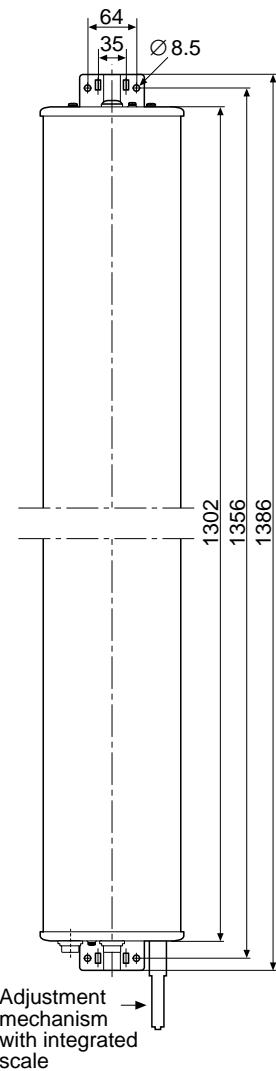

## Description of the adjustment mechanism (protective cap removed):



- ① Adjustment wheel with twist-lock function.
- ② Downtilt spindle with integrated scale.



- ① Thread for fixing the protective cap or the RCU (Remote Control Unit).
- ② Gearwheel for RCU power drive.

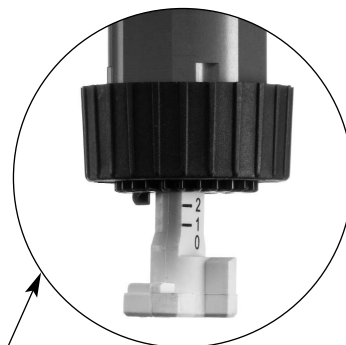

To set the downtilt angle exactly, you must look horizontally at the scale. The lower edge of the gear-wheel must be used for alignment.

## Manual adjustment procedure:



Remove the protective cap.

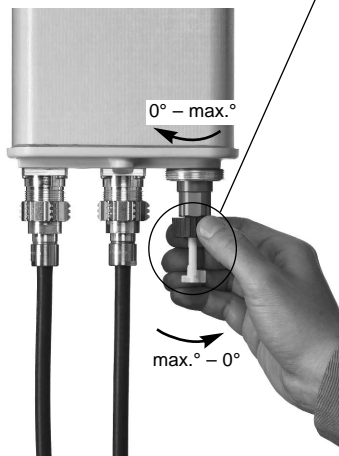

Set downtilt angle by rotating the adjustment wheel.



Screw on the protective cap again.

## Optional: RCU (Remote Control Unit) for remote-controlled downtilt adjustment:



936.2374/c Subject to alteration.

**For a description of RCU installation please refer to the respective data sheet.**