

**Panel** 806–960  
**Dual Polarization** X  
**Half-power Beam Width** 65°  
**Adjust. Electr. Downtilt** 0°–10°  
 set by hand or by optional RCU (Remote Control Unit)

XPoI Panel 806–960 65° 16.3dBi 0°–10°T

Type No.	800 10304		
Frequency range	<span style="border: 1px solid black; padding: 2px;">806–960</span>		
	806 – 866 MHz	824 – 894 MHz	880 – 960 MHz
Polarization	+45°, –45°	+45°, –45	+45°, –45°
Average gain (dBi)	15.6 ... 15.8 ... 15.5	15.7 ... 16.1 ... 15.7	16 ... 16.3 ... 15.9
Tilt	0° ... 5° ... 10°	0° ... 5° ... 10°	0° ... 5° ... 10°
<b>Horizontal Pattern:</b>			
Half-power beam width	69°	67°	65°
Front-to-back ratio, copolar	> 25 dB	> 25 dB	> 25 dB
Cross polar ratio			
Maindirection	0°	Typically: 25 dB	Typically: 25 dB
Sector	±60°	> 10 dB	> 10 dB
<b>Vertical Pattern:</b>			
Half-power beam width	12.5°	12°	11.5°
Electrical tilt	0°–10°, continuously adjustable		
Sidelobe suppression for first sidelobe above horizon	0° ... 3° ... 6° ... 10° T 15 ... 14 ... 12 ... 12 dB	0° ... 3° ... 6° ... 10° T 15 ... 15 ... 15 ... 14 dB	0° ... 3° ... 6° ... 10° T 15 ... 15 ... 15 ... 14 dB
Impedance	50 Ω		
VSWR	< 1.5		
Isolation, between ports	> 30 dB		
Intermodulation IM3	< –150 dBc (2 x 43 dBm carrier)		
Max. power per input	400 W (at 50 °C ambient temperature)		



880 – 960 MHz: +45°/–45° Polarization

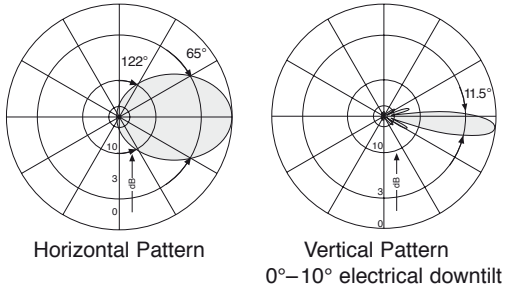

824 – 894 MHz: +45°/–45° Polarization

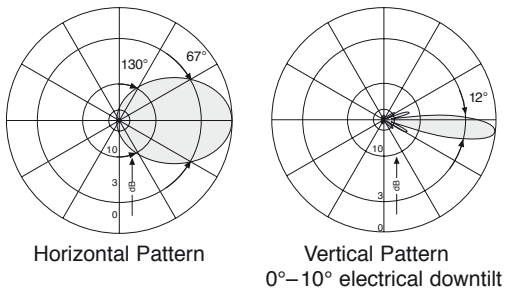

806 – 866 MHz: +45°/–45° Polarization

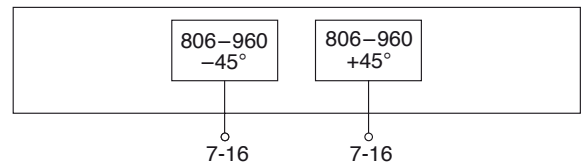
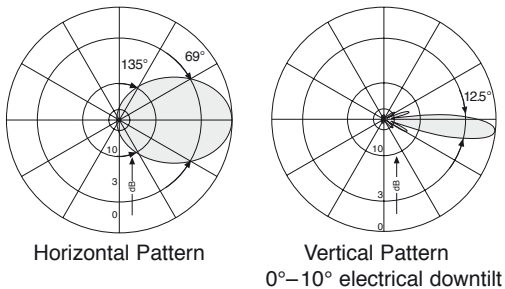

**Mechanical specifications**

Input	2 x 7-16 female
Connector position	Rearside, pointing downwards
Adjustment mechanism	1x, Position bottom continuously adjustable
Weight	13 kg
Wind load	Frontal: 300 N (at 150 km/h) Lateral: 195 N (at 150 km/h) Rearside: 660 N (at 150 km/h)
Max. wind velocity	200 km/h
Packing size	1976 x 292 x 192 mm
Height/width/depth	1694 / 259 / 99 mm

936.2847/b Subject to alteration.

### Accessories (order separately)

Type No.	Description	Remarks	Weight approx.	Units per antenna
731 651	1 clamp	Mast: 28 – 64 mm diameter	330 g	2
738 546	1 clamp	Mast: 50 – 115 mm diameter	1.0 kg	2
850 10002	1 clamp	Mast: 110 – 220 mm diameter	2.7 kg	2
850 10003	1 clamp	Mast: 210 – 380 mm diameter	4.8 kg	2
733 677	1 clamp	Mast: 60 – 115 mm diameter	2.0 kg	2
733 678	1 clamp	Mast: 115 – 210 mm diameter	2.6 kg	2
733 679	1 clamp	Mast: 210 – 380 mm diameter	4.0 kg	2
733 680	1 clamp	Mast: 380 – 521 mm diameter	5.3 kg	2
737 978	1 downtilt kit	Downtilt angle: 0° – 12°	2.8 kg	1

For downtilt mounting use the clamps for an appropriate mast diameter together with the downtilt kit.

#### Material:

**Reflector screen:** Weather-proof aluminum.

**Fiberglass radome:** The grey fiberglass radomes of these antennas are very stable and extraordinarily stiff. They are resistant to ultraviolet radiation and can also be painted to match their surroundings.

**All screws and nuts:** Stainless steel.

#### Grounding:

The metal parts of the antenna including the mounting kit and the inner conductors are DC grounded.

#### Environmental conditions:

Kathrein cellular antennas are designed to operate under the environmental conditions as described in ETS 300 019-1-4 class 4.1 E.

The antennas exceed this standard with regard to the following items:

- Low temperature: –55 °C
- High temperature (dry): +60 °C

**Ice protection:** Due to the very sturdy antenna construction and the protection of the radiating system by the radome, the antenna remains operational even under icy conditions.

#### Environmental tests:

Kathrein antennas have passed environmental tests as recommended in ETS 300 019-2-4. The homogenous design of Kathrein's antenna families use identical modules and materials. Extensive tests have been performed on typical samples and modules.

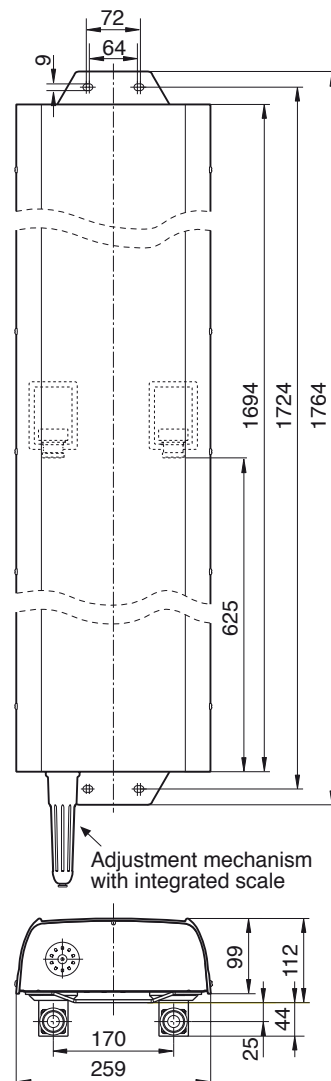

#### Please note:

**As a result of more stringent legal regulations and judgements regarding product liability, we are obliged to point out certain risks that may arise when products are used under extraordinary operating conditions.**

The mechanical design is based on the environmental conditions as stipulated in ETS 300 019-1-4, which includes the static mechanical load imposed on an antenna by wind at maximum velocity. Extraordinary operating conditions, such as heavy icing or exceptional dynamic stress (e.g. strain caused by oscillating support structures), may result in the breakage of an antenna or even cause it to fall to the ground. These facts must be considered during the site planning process.

**The installation team must be properly qualified and also be familiar with the relevant national safety regulations.**

**The details given in our data sheets have to be followed carefully when installing the antennas and accessories.**

**The limits for the coupling torque of RF-connectors, recommended by the connector manufacturers must be obeyed.**

**Any previous datasheet issues have now become invalid.**



## Description of the adjustment mechanism (protective cap removed):



- ① Adjustment wheel with twist-lock function.
- ② Downtilt spindle with integrated scale.



- ① Thread for fixing the protective cap or the RCU (Remote Control Unit).
- ② Gearwheel for RCU power drive.

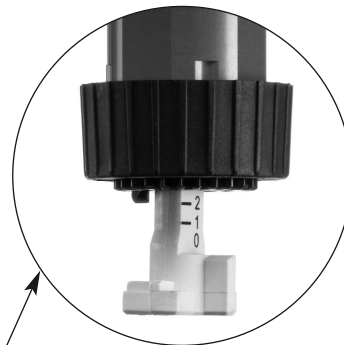

To set the downtilt angle exactly, you must look horizontally at the scale. The lower edge of the gear-wheel must be used for alignment.

## Manual adjustment procedure:



Remove the protective cap.

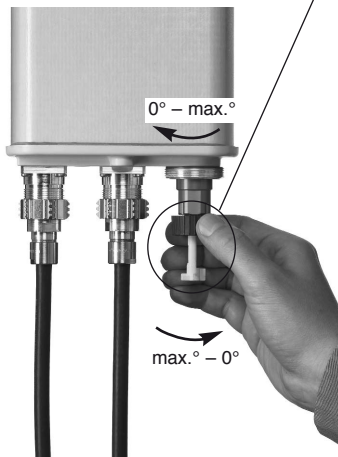

Set downtilt angle by rotating the adjustment wheel.



Screw on the protective cap again.

## Optional: RCU (Remote Control Unit) for remote-controlled downtilt adjustment:

936.2847/b Subject to alteration.



For a description of RCU installation please refer to the respective data sheet.