



Contents Overview

Chapter Overview

Type Index

R&S Addresses

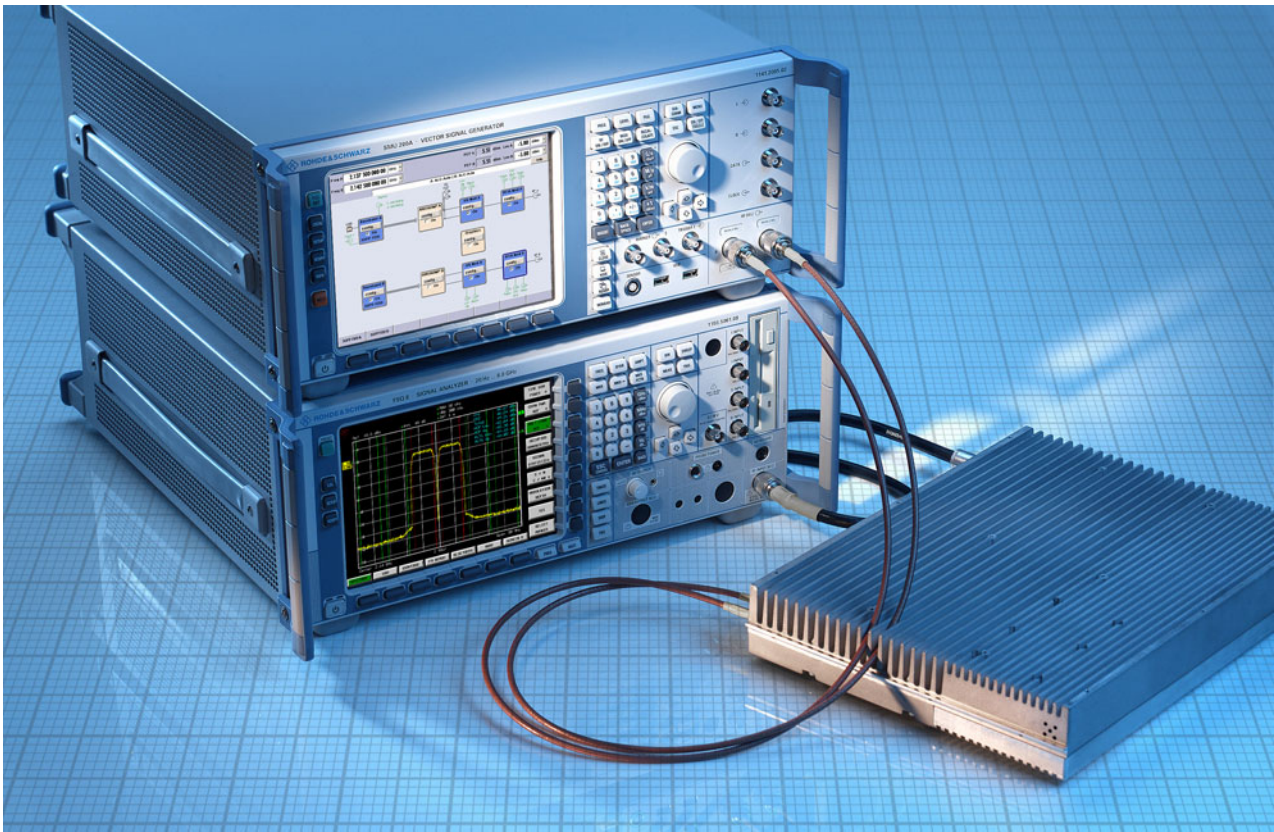

*New approaches in generation and analyzation of complex I/Q Signals with Vector Signal Generator R&S® SMU200A and Signal Analyzer R&S® FSQ8*



Contents Overview

Chapter Overview

Type Index

R&S Addresses





Contents Overview

Chapter Overview

Type Index

R&amp;S Addresses



## Contents of Chapter 5

Designation	Type	Description	Page
<b>Vector Signal Generators</b>			
100 kHz to 6 GHz	R&S®SMU200A	Two independent signal generators in one cabinet with unrivalled RF and baseband characteristics	226
300 kHz to 2.2 GHz 300 kHz to 3.3 GHz 300 kHz to 4.4 GHz 300 kHz to 6.4 GHz 300 kHz to 3.3 GHz	R&S®SMIQ02B R&S®SMIQ03B R&S®SMIQ04B R&S®SMIQ06B R&S®SMIQ03HD	Signal Generator Family for analog and digital modulation is offering solutions for today and tomorrow. This series particularly takes into account future developments in the field of 3rd-generation digital mobile radio.  Dedicated to 3GPP, special model of Vector Signal Generator R&S®SMIQ	232  238
9 kHz to 3.3 GHz	R&S®SMV03	Based on the analog Signal Generator R&S®SML03. It comprises an additional broadband I/Q modulator which is able to generate any digital signal in conjunction with an external I/Q source	240
<b>RF Signal Generators</b>			
5 kHz to 1.5 GHz 5 kHz to 3 GHz 5 kHz to 6 GHz	R&S®SMT02 R&S®SMT03 R&S®SMT06	For all fields of analog receiver measurements as well as EMS applications Same as R&S®SMT02, but enhanced frequency range Same as R&S®SMT02, but enhanced frequency range	244
9 kHz to 1.1 GHz 9 kHz to 2.2 GHz 9 kHz to 3.3 GHz	R&S®SML01 R&S®SML02 R&S®SML03	Offers all features required of a state-of-the-art general-purpose signal generator: wide frequency range, large variety of modulation functions and high reliability – at an extremely attractive price.	246
9 kHz to 3 GHz	R&S®SM300	Professional signal generator for production, laboratory and service	249
<b>Microwave Signal Generators</b>			
0.01/2 GHz to 20 GHz 0.01/2 GHz to 20 GHz 0.01/2 GHz to 27 GHz 0.01/2 GHz to 40 GHz	R&S®SMP02 R&S®SMP22 R&S®SMP03 R&S®SMP04	A reliable, high-precision signal source featuring high output power, high spectral purity and excellent pulse modulation. It is able to supply signals for any measurements on radar and communications receivers.	251
1 GHz to 20 GHz 1 GHz to 27 GHz 1 GHz to 30 GHz 1 GHz to 40 GHz 1 GHz to 50 GHz 1 GHz to 60 GHz	R&S®SMR20 R&S®SMR27 R&S®SMR30 R&S®SMR40 R&S®SMR50 R&S®SMR60	The R&S®SMR family comprises four basic models designed as CW generators with pulse modulation capability. Offering an excellent price/performance ratio, each of the four basic models is ideal for the user wishing to enter the field of microwave testing at an affordable price.  High-performance, cost-effective and reliable up to 60 GHz	255  258
<b>Function and ARB Generators</b>			
14 (16) bit, 16 Msample	R&S®AMIQ04	Dual-channel modulation generator that has consequently been designed for use as an I/Q source. It is programmed and set with Software R&S®WinIQSIM™. Alternatively, R&S®AMIQ can be operated from a Vector Signal Generator R&S®SMIQ	261
DC up to 50 MHz 100 Msample/s	R&S®AM300	Dual-channel arbitrary/function generator that offers superb functionality and spectral purity at a favourable price	266
<b>Simulation Software</b>	R&S®WinIQSIM™	Ideal for the generation of digitally modulated signals	263
<b>Baseband Fading Simulator</b>	R&S®ABFS	Saving costs through real-world fading tests	268



Contents Overview

Chapter Overview

Type Index

R&amp;S Addresses



## Vector Signal Generator R&amp;S®SMU200A

New

**Up to two independent signal generators in one cabinet with unrivalled RF and baseband characteristics**

*Vector Signal Generator R&S®SMU200A with 6 GHz RF path A and 3 GHz RF path B and fading simulator*

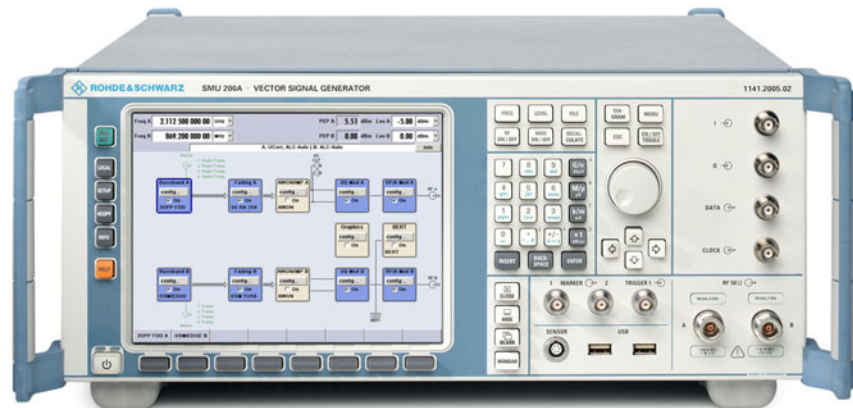

## Brief description

The Vector Signal Generator R&S®SMU200A has been designed to meet all requirements encountered in research and development of modern communication systems as well as in their production. The R&S®SMU200A not only combines up to two independent signal generators in one cabinet of only four height units, it also offers unrivalled RF and baseband characteristics.

Due to its modular design, the R&S®SMU200A can be optimally adapted to the requirements of different applications. The first RF path can be equipped with one of the four available frequency options. The upper frequency limit of 2.2/3/4 GHz or 6 GHz is user-

selectable. In addition a second RF path can be installed with upper frequency limits of 2.2 GHz and 3 GHz. The lower frequency limit of all frequency options is 100 kHz.

Up to two generators can also be installed in the baseband section. They generate complex signals in realtime and are equipped with an arbitrary waveform generator with 56 Msample memory for

I and Q and 4 marker bits per sample (256 Mbyte). The signals generated in the different basebands can be added even with frequency offset.

The modern, intuitive concept of the R&S®SMU200A ensures fast and easy operation.

## Main features

**Two signal generators in one**

- ◆ Frequency options from 100 kHz to 2.2/3/4/6 GHz for the first RF path
- ◆ Optional second RF path up to 2.2 GHz or 3 GHz
- ◆ Up to two complete baseband paths
- ◆ Lossless combination of baseband signals in the digital domain (e.g. for testing multistandard base stations)

**Outstanding signal quality**

- ◆ I/Q modulator with 200 MHz RF bandwidth
- ◆ Very low SSB phase noise of typ.  $-135$  dBc ( $f = 1$  GHz, 20 kHz carrier offset, 1 Hz measurement bandwidth)
- ◆ Wideband noise of typ.  $-153$  dBc (CW,  $f = 1$  GHz,  $>5$  MHz carrier offset, 1 Hz measurement bandwidth)
- ◆ Excellent ACLR of typically  $+70$  dB for 3GPP FDD (test model 1, 64 DPCH)
- ◆ Very high level repeatability of 0.05 dB
- ◆ High output power up to  $+19$  dBm (PEP), overrange  $+26$  dBm
- ◆ High-stability reference oscillator as standard

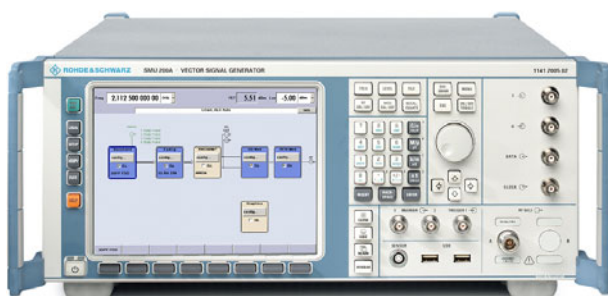

*Vector Signal Generator R&S®SMU200A equipped with only one RF path*

## Vector Signal Generator R&S®SMU200A

### Unrivalled flexibility

- ◆ Four code channels in realtime for 3GPP
- ◆ Eight code channels in real time for cdma2000
- ◆ Change of modulation from slot to slot for GSM/EDGE
- ◆ Baseband generator with universal coder for realtime signal generation
- ◆ Arbitrary waveform generator with 56 Msample for I and Q and 4 marker bits per sample (256 Mbyte)
- ◆ Arbitrary waveform generator supported by Simulation Software R&S®WinIQSIM™
- ◆ Internal hard disk provided as standard for storing waveforms and modulation data
- ◆ Fading simulator with up to 40 paths

### Intuitive operation

- ◆ Colour display with 800 × 600 pixels (SVGA format)
- ◆ Intuitive user interface with graphical display of signal flow
- ◆ Graphical display of baseband signals through built-in transient recorder
- ◆ Context-sensitive help system

### Ideal for production

- ◆ Very short frequency setting times (<3 ms); only 450 μs in List mode
- ◆ Electronic attenuator up to 6 GHz
- ◆ Minimum space required as two complete generators are accommodated in one cabinet of only four height units

### Connectivity

- ◆ Can be remote-controlled via GPIB and LAN
- ◆ USB connectors for keyboard, mouse and memory stick
- ◆ User-selectable trigger and marker signals

### Characteristics

#### Intuitive operation

The R&S®SMU200A is equipped with a modern and intuitive user interface. The signal flow from the baseband to the RF output is clearly shown in the block diagram. Each block represents a functional unit of the instrument. The generated signal can be seen at a glance, and whether it is affected by additive white Gaussian noise or other impairments.

The baseband signal can be monitored in the graphics block. For instance, the vector or constellation diagram, the I/Q characteristic or the output spectrum of a signal can be displayed, making

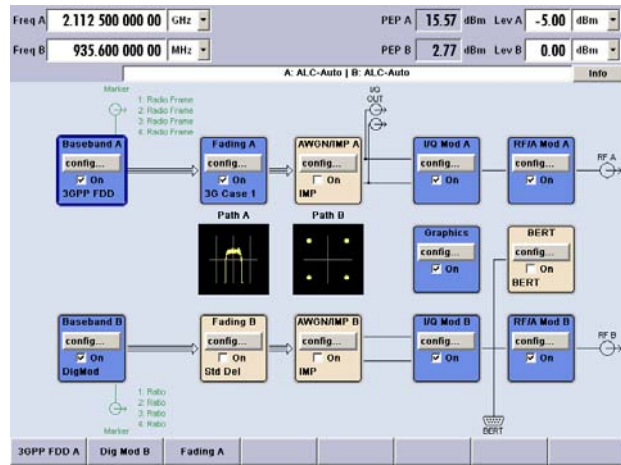

Block diagram of the R&S®SMU200A (2 paths)

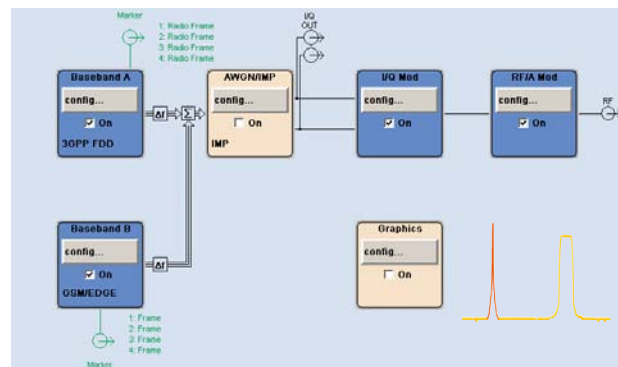

Generation of 3GPP and GSM/EDGE signals in realtime

it possible to check whether the generated signal corresponds to the required signal. This is of great help particularly when complex signals are produced.

Another outstanding feature of the R&S SMU200A is its context-sensitive online help. If the exact function of a parameter is not known, simply pushing the help key instantaneously displays a help text with information about the selected parameter. Further information can be obtained through navigation with a browser-like system. The help system also specifies the relevant remote-control commands. Full-text searching in the help system, which contains the complete operating manual, comes in handy when complex measurement tasks are to be performed. Tool tips are provided in addition. If you pause on a parameter, the currently permissible setting range is displayed.





Contents Overview

Chapter Overview

Type Index

R&S Addresses



## Vector Signal Generator R&S®SMU200A

### Outstanding signal quality

Owing to the sophisticated multiloop synthesizer concept, the R&S®SMU200A features extremely low SSB phase noise and wideband noise. A high-stability ovencontrolled reference oscillator is installed as standard, which provides excellent aging characteristics as well as minimum temperature drift. The R&S®SMU200A is ideal, for instance, for LO or VCO substitution.

Amplifiers of 3GPP base stations require very good adjacent channel leakage ratio (ACLR) performance in order not to impair the adjacent channels of the transmission. To test this feature, the ACLR characteristics of the signal generator must be better than those of the amplifier. Presently, multicarrier power amplifiers are increasingly used. In this case, not only one but several neighbouring signals in the frequency range are amplified. Testing such amplifiers places even higher demands on signal generator capabilities. The outstanding ACLR characteristics of the R&S®SMU200A more than qualify the generator for this task.

When external I/Q signals are applied, the R&S®SMU200A features an RF bandwidth of 200 MHz. If the internal baseband is used, an RF bandwidth of 80 MHz is available, which is ideal for testing multicarrier amplifiers. The R&S®SMU200A is thus well prepared for future broadband systems.

The R&S®SMU200A offers highly accurate output power of up to +13 dBm (PEP). A wear-and-tear-free electronic attenuator is used in the full level range. With the aid of the "high-power output" option, the output power can be increased to +26 dBm (PEP) in the overrange.

Digital ALC implemented in the R&S®SMU200A together with a detector operating at constant temperature ensures high level linearity and repeatability. ALC may be on for most kinds of complex signal scenarios.

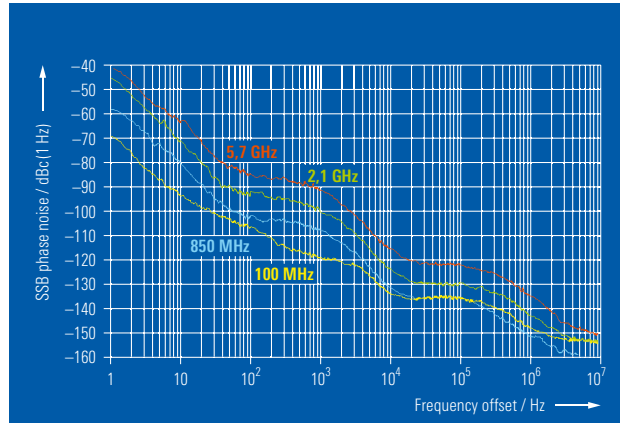

Typical SSB phase noise at 100 MHz, 850 MHz, 2.1 GHz and 5.7 GHz

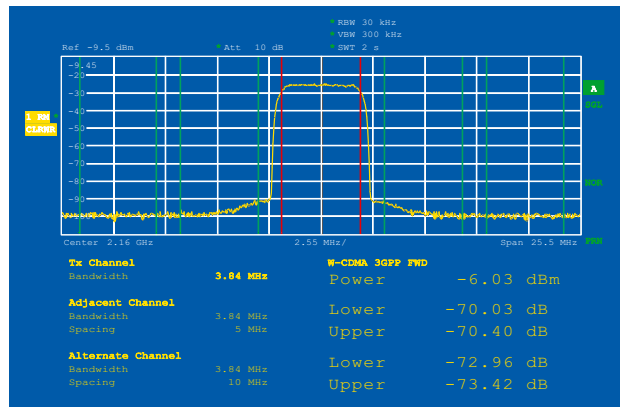

Outstanding ACLR characteristics

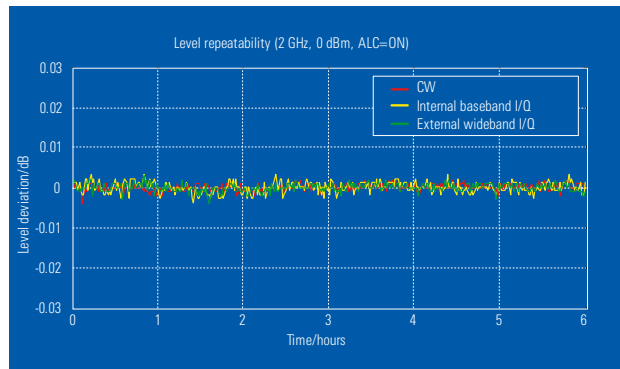

High level repeatability of the R&S®SMU200



Contents Overview

Chapter Overview

Type Index

R&S Addresses



## Vector Signal Generator R&S®SMU200A

### Unrivalled flexibility

The standards of the third mobile radio generation set considerably higher demands on signal generator functionality. Because of their good RF characteristics and their flexibility, signal generators are the instrument of choice particularly when base stations are tested. The universal coder in the baseband generator of the R&S®SMU200A has been designed for easy implementation of new standards. The R&S®SMU200A is therefore well prepared for present and future mobile radio standards.

All the strengths of the two-path concept of the R&S®SMU200A become specially evident in the field of mobile radio. Since the baseband section of the R&S®SMU200A is fully digital, the signals of the two baseband generators can be easily added without synchronization problems and without an external coupler or additional equipment being required. A frequency offset and the relative power of each signal can be accurately set.

### Fading

The R&S®SMU200A permits baseband signal fading in realtime. If all options are installed, up to 40 fading paths are available for a fader, or 20 fading paths each for dual-channel fading. Both channels can be connected differently for the various test scenarios. For example, frequency diversity can be simulated with the same input signals and two separate output signals. Or, network handover can be simulated with separate input signals that are added together after fading.

A comprehensive scope of default settings in accordance with the test specifications of the main mobile radio standards (3GPP test scenarios included) facilitate the use of the R&S®SMU200A in the research, development and quality control of mobile radios. All parameters of the available fading configurations are user-definable for more detailed tests.

### Remote control

The R&S®SMU200A is remote-controlled via GPIB or LAN. When the Windows Remote Desktop is used, the instrument can be remote-operated from a PC.

### Convenient service

"Low cost of ownership" is more than just a motto – it is a fully fledged concept. The three-year calibration cycle considerably reduces costs.

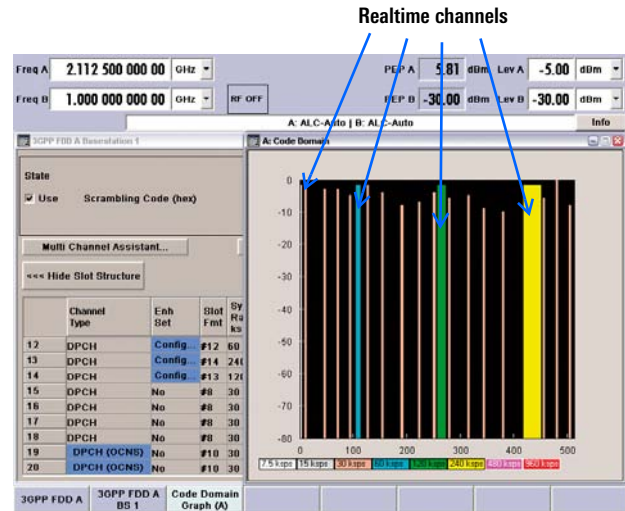

Four code channels in realtime with additional background channels

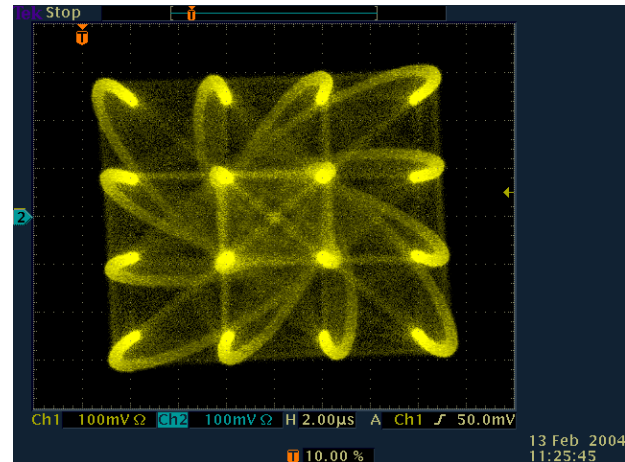

16QAM faded by a Rayleigh channel

A thermal management with oversized fans combined with large-scale integration ensures high reliability even under adverse environmental conditions.

Rohde&Schwarz Service Centers all over the world reduce transit times in the case of repair and ensure short turnaround times.



## Vector Signal Generator R&S®SMU200A

### Specifications in brief

You will find detailed and binding data on the enclosed CD

(./DATASHEET/SMU200A.pdf), or, for the latest updates, visit [www.rohde-schwarz.com](http://www.rohde-schwarz.com), search term: SMU200A

<b>Frequency</b>		
Frequency range	depending on frequency options	100 kHz to 2.2/3/4/6 GHz
Setting time	To within $<1 \times 10^{-7}$ for $f > 200$ MHz or $<124$ Hz for $f < 200$ MHz after IEC/IEEE bus delimiter	$<3$ ms
Setting time in List mode	after trigger pulse in List mode	$<450$ $\mu$ s
<b>Sweep</b>	Operating modes	digital sweep in discrete steps automatic, single shot, manual or external trigger, linear or logarithmic
<b>Level</b>		
Range	PEP, 3 GHz with high-power output option	-145 dBm to +13 dBm -145 dBm to +19 dBm
Accuracy	Levels $>120$ dBm, attenuator mode "auto", temperature range 18°C to 33°C, $f \leq 3$ GHz	$<0.5$ dB
<b>Spectral purity</b>		
Nonharmonics	$>850$ kHz offset from carrier and outside the modulation spectrum, $200 \text{ MHz} < f \leq 1500 \text{ MHz}$	$<-86$ dBc
Wideband noise	Carrier offset $>5$ MHz, measurement bandwidth 1 Hz, CW, $200 \text{ MHz} < f \leq 3 \text{ GHz}$	typ. -153 dBc
SSB phase noise	Carrier offset 20 kHz, measurement bandwidth 1 Hz, unmodulated, $20 \text{ MHz} \leq f \leq 200 \text{ MHz}$ , $f = 1 \text{ GHz}$	typ. -135 dBc
<b>ACLR</b>		
3GPP test model 1, 64 DPCH		typ. 70 dB
RF modulation bandwidth	using external I/Q inputs using internal baseband section	200 MHz 80 MHz
<b>Supported modulation types</b>		
AM		DC to 500 kHz
Pulse		0 Hz to 100 kHz
ASK		0% to 100%
FSK		MSK, 2FSK, 4FSK
PSK		BPSK, QPSK, OQPSK, $\pi/2$ DBPSK, $\pi/4$ DQPSK, $\pi/8$ D8PSK, $\pi/4$ QPSK, 8PSK, 8PSK EDGE
QAM		16QAM, 32QAM, 64QAM, 256QAM, 1024QAM
<b>Supported standards and digital systems</b>		GSM/EDGE, 3GPP FDD, 3GPP TDD, TD-SCDMA, cdmaOne, cdma2000, 1xEV-DO, IEEE 802.11a, IEEE 802.11b, IEEE 802.11g, TETRA, <i>Bluetooth</i> , AWGN, user-defined multicarrier CW
<b>General data</b>		
Interfaces		IEEE488.2, LAN (100BaseT), 3 $\times$ USB, 1 $\times$ USB slave, VGA
Power supply		100 V AC to 240 V AC, 47 Hz to 63 Hz
Operating temperature range		5°C to 45°C
Dimensions (W $\times$ H $\times$ D)		435 mm $\times$ 192 mm $\times$ 460 mm
Weight (fully equipped)		25 kg



## Vector Signal Generator R&S®SMU200A

### Ordering information

Designation	Remarks	Type	Order No.
<b>Vector Signal Generator<sup>1)</sup></b>	Basic unit, requires frequency option for path A	R&S®SMU200A	1141.2005.02
including power cable, Quick Start Guide and CD-ROM (with operating and service manual)			
<b>Options</b>			
RF Path A			
100 kHz to 2.2 GHz	factory fitted only	R&S®SMU-B102	1141.8503.02
100 kHz to 3 GHz	factory fitted only	R&S®SMU-B103	1141.8603.02
100 kHz to 4 GHz	factory fitted only	R&S®SMU-B104	1141.8703.02
100 kHz to 6 GHz	factory fitted only	R&S®SMU-B106	1141.8803.02
Overvoltage Protection	factory fitted only	R&S®SMU-B30	1159.7444.02
High-Power Output	factory fitted only	R&S®SMU-B31	1159.8011.02
Overvoltage Protection and High-Power Output	factory fitted only	R&S®SMU-B32	1160.0256.02
RF Path B			
100 kHz to 2.2 GHz	factory fitted only	R&S®SMU-B202	1141.9400.02
100 kHz to 3 GHz	factory fitted only	R&S®SMU-B203	1141.9500.02
Overvoltage Protection	factory fitted only	R&S®SMU-B35	1160.0633.02
High-Power Output	factory fitted only	R&S®SMU-B36	1160.1000.02
Overvoltage Protection and High-Power Output	factory fitted only	R&S®SMU-B37	1160.1400.02
Baseband			
Baseband Generator with ARB (56 Msample) and Digital Modulation (realtime)	factory fitted only	R&S®SMU-B10	1141.7007.02
Baseband Generator with ARB (12 Msample) and Digital Modulation (realtime)	factory fitted only	R&S®SMU-B11	1159.8411.02
Baseband Main Module	factory fitted only	R&S®SMU-B13	1141.8003.02
Digital modulation systems			
Digital Standard GSM/EDGE	R&S®SMU-B10 required	R&S®SMU-K40	1160.7609.02
Digital Standard 3GPP FDD	R&S®SMU-B10 required	R&S®SMU-K42	1160.7909.02
3GPP FDD Enhanced MS/BS Tests incl. HSDPA	R&S®SMU-B10 required	R&S®SMU-K43	1160.9660.02
Digital Standard cdma2000 incl 1xEV-DV	R&S®SMU-B10 required	R&S®SMU-K46	1160.9876.02
Multicarrier CW Signal Generation	R&S®SMU-B10 required	R&S®SMU-K61	1160.8505.02
Digital modulation systems using R&S®WinIQSIM™ <sup>2)</sup>			
Digital Standard IS-95	R&S®WinIQSIM™ and R&S®SMU-B10 required	R&S®SMU-K11	1160.5335.02
Digital Standard cdma2000	R&S®WinIQSIM™ and R&S®SMU-B10 required	R&S®SMU-K12	1160.5658.02
Digital Standard 3GPP TDD	R&S®WinIQSIM™ and R&S®SMU-B10 required	R&S®SMU-K13	1160.5906.02
Digital Standard TD-SCDMA	R&S®WinIQSIM™ and R&S®SMU-B10 required	R&S®SMU-K14	1160.6202.02
User-Defined OFDM Signals	R&S®WinIQSIM™ and R&S®SMU-B10 required	R&S®SMU-K15	1160.6402.02
Digital Standard 1xEV-DO	R&S®WinIQSIM™ and R&S®SMU-B10 required	R&S®SMU-K17	1160.7009.02
Digital Standard IEEE 802.11 (a/b/g)	R&S®WinIQSIM™ and R&S®SMU-B10 required	R&S®SMU-K19	1160.8805.02
Digital Standard 3GPP FDD incl HSDPA	R&S®WinIQSIM™ and R&S®SMU-B10 required	R&S®SMU-K20	1160.9460.02
Fading and noise			
Fading Simulator	expected to be available as from October 2004	R&S®SMU-B14	1160.1800.02
Fading Simulator Extension	expected to be available as from October 2004	R&S®SMU-B15	1160.2288.02
Additive White Gaussian Noise (AWGN)	R&S®SMU-B13 required	R&S®SMU-K62	1159.8511.02
Dynamic Fading and Enhanced Resolution	expected to be available as from October 2004	R&S®SMU-K71	1160.9201.02
Bit Error Rate Tester		R&S®SMU-K80	1159.8770.02
<b>Recommended extras</b>			
DKD Calibration incl. ISO 9000 Calibration	ordering with device only	R&S®SMU200DKD	1136.3536.02
Documentation of Calibration Values R&S®SMU200A		R&S®SMU-DCV	0240.2193.18
19" Rack Adapter		R&S®ZZA-411	1096.3283.00
Adapter for Telescopic Sliders		R&S®ZZA-T45	1109.3774.00
BNC Adapter Board for AUX I/O connector		R&S®SMU-Z5	1160.4545.02
Keyboard with USB Interface (US assignment)		R&S®PSL-Z2	1157.6870.03
Mouse with USB Interface, optical		R&S®PSL-Z10	1157.7060.02
External USB CD-RW Drive		R&S®PSP-B6	1134.8201.12

<sup>1)</sup> The base unit can only be ordered together with an R&S®SMU-B10x frequency option.

<sup>2)</sup> R&S®WinIQSIM™ requires an external PC.



## Vector Signal Generator R&S® SMIQ

**R&S® SMIQ02B/03B/04B/06B:**  
**300 kHz to 2.2/3.3/4.4/6.4 GHz**  
**Digital signals of your choice**

*Vector Signal Generator R&S® SMIQ03B*

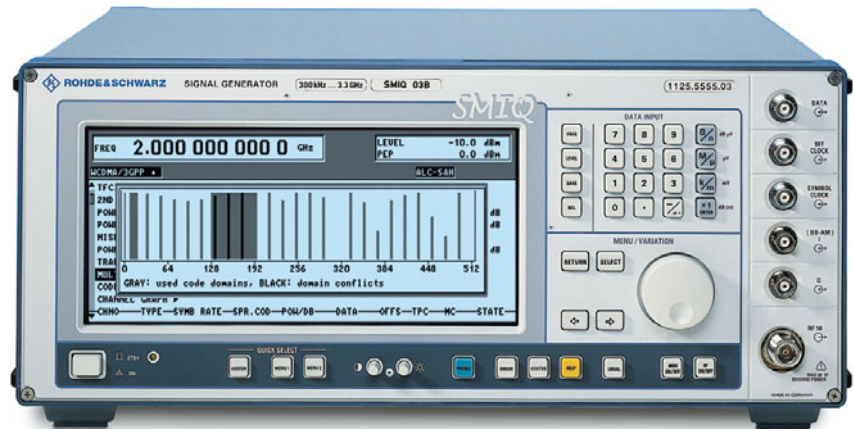

### Brief description

The B series of Signal Generator Family R&S® SMIQ for analog and digital modulation is offering solutions for today and tomorrow. This series particularly takes into account future developments in the field of 3rd-generation digital mobile radio.

The R&S® SMIQ family comprises four models which differ in their upper frequency limits. These feature a hitherto unrivalled versatility regarding signal generation and signal quality and are therefore ideal for use in development and type-approval testing.

With their outstanding price/performance ratio, these signal generators are also economically attractive for applications in production. The wide frequency range from 300 kHz to 6.4 GHz covers all main radio bands including their IF ranges.

The high-grade I/Q modulator fitted as standard ensures minimum error vector magnitude and high intermodulation suppression. Using modern digital signal processor (DSP) technology, the versatile concept allows the generation of high-precision digital modulation signals with

high bit rates without any limitations on modulation modes or standards.

In addition to digital modulation, the signal generators provide the full range of analog modulation modes as well as simultaneous modulation capability.

### Applications

- ◆ Type-approval testing of digital base and mobile stations
- ◆ Base-station transmitter test
- ◆ Sensitivity measurements on digital receivers
- ◆ Selectivity measurements on digital receivers
- ◆ Testing of equalizers
- ◆ Tolerance tests on digital systems
- ◆ Components tests
- ◆ Development of new digital communication systems

### Main features

- ◆ Frequency range 300 kHz to 2.2/3.3/4.4/6.4 GHz
- ◆ Analog and digital modulation
- ◆ Versatile and broadband generation of digitally modulated signals up to 18 Msymbol/s
- ◆ Generation of TDMA, CDMA, WCDMA and cdma2000 standard signals to all main mobile radio standards

- ◆ Broadband I/Q modulator with outstanding vector accuracy
- ◆ Optional internal fading simulator to test specifications of mobile radio standards
- ◆ Optional internal noise generator and distortion simulator
- ◆ Optional BER measurement
- ◆ Optional arbitrary waveform generator
- ◆ Low ACP for IS-95 CDMA and WCDMA (option)
- ◆ Low cost of ownership due to three-year calibration intervals
- ◆ Future-oriented platform concept
- ◆ Unrivalled price/performance ratio

### Characteristics

#### Digital modulation

Any digital modulation modes (with option R&S® SMIQB20)

- ◆ Free choice of modulation mode from ASK through to 256QAM
- ◆ Any kind of baseband filtering with variable filter parameters
- ◆ Symbol rate adjustable up to 18 Msymbol/s
- ◆ Realtime coding of internal and external data
- ◆ Internal PRBS generators



Contents Overview

Chapter Overview

Type Index

R&S Addresses



## R&S®SMIQ: Overview of options

Application <sup>1)</sup>	R&S®SM-B1	R&S®SM-B5	R&S®SMIOB11 <sup>2)</sup>	R&S®SMIOB12	R&S®SMIOB14	R&S®SMIOB15	R&S®SMIOB17	R&S®SMIOB20	R&S®SMIOB21	R&S®SMIOB42 <sup>3)</sup>	R&S®SMIOB43 <sup>3)</sup>	R&S®SMIOB45 <sup>3)</sup>	R&S®SMIOB47	R&S®SMIOB48	R&S®SMIOB49	R&S®SMIOB51 <sup>3)</sup>	R&S®SMIOB60	R&S®SMIO-K5 <sup>3)</sup>	R&S®SMIO-K8 <sup>3)</sup>	R&S®SMIOK11	R&S®SMIOK12	R&S®SMIOK13	R&S®SMIOK14	R&S®SMIOK15	R&S®SMIOK17	R&S®SMIOK19	R&S®SMIOK20	
Reference Oscillator OCXO																												
FM/φM Modulator																												
Data Generator (15 Mbit RAM)																												
Memory Extension, 32 Mbit																												
Fading Simulator (6 paths)																												
2nd Fading Simulator (6 paths)																												
Noise Generator and Distortion Simulator																												
Digital Modulation Coder																												
BER measurement																												
Digital Standard IS-95 CDMA																												
Digital Standard WCDMA (NTT DoCoMo 1.0, ARIB 0.0)																												
Digital Standard WCDMA according to 3GPP (FDD)																												
Low ACP for IS-95 CDMA and WCDMA																												
Extended Functions for WCDMA 3GPP																												
Extended Fading Functions for WCDMA 3GPP																												
Digital Standard IGPS																												
Arbitrary Waveform Generator																												
Digital Standard <i>Bluetooth</i>																												
Digital Standard TETRA																												
Digital Standard IS-95 CDMA (with ARB R&S®SMIOB60)																												
Digital Standard cdma2000 (with ARB R&S®SMIOB60)																												
Digital Std. WCDMA 3GPP TDD (with ARB R&S®SMIOB60)																												
Digital Standard TD-SCDMA (with ARB R&S®SMIOB60)																												
OFDM Signal Generation (with ARB R&S®SMIOB60)																												
Digital Standard 1xEV-DO (with ARB R&S®SMIOB60)																												
Digital Standard IEEE802.11 (with ARB R&S®SMIOB60)																												
Dig. Std. 3GPPFDDA incl. HSDPA (with ARB R&S®SMIOB60)																												

1) R&S®SMIQ2B/03B (R&S®SMIQ04B/06B) can be equipped with up to three (two) of the following options: R&S®SM-B5, R&S®SMIOB14, R&S®SMIOB15 or R&S®SMIOB17.  
 2) Option R&S®SMIOB20 required. ● = required  
 3) Options R&S®SMIOB20 and R&S®SMIOB11 required. ○ = optional



Contents Overview

Chapter Overview

Type Index

R&S Addresses





Contents Overview

Chapter Overview

Type Index

R&amp;S Addresses



## Vector Signal Generator R&S®SMIQ

Convenient burst generation for TDMA standards (with option R&S®SMIQB20/R&S®SMIQB11)

- ◆ TDMA mobile radio standards provided as standard GSM, GSM/EDGE, DECT, NADC (IS-54C/IS-136), PDC, PHS
- ◆ Versatile external synchronization capabilities
- ◆ Realtime processing of external and internal data
- ◆ Generation of TDMA frames with versatile timeslot configuration
- ◆ Continuous PRBS sequences
- ◆ Optimization of burst shaping to reduce spectra due to switching
- ◆ Realtime processing with external data for BER tests
- ◆ Fast Slot-by-slot modulation change at GSM/EDGE

### Analog modulation

- ◆ Broadband AM with up to 30 MHz modulation frequency
- ◆ I/Q modulation with 30 MHz modulation bandwidth (3 dB), 60 MHz RF bandwidth
- ◆ Unprecedented vector accuracy and high intermodulation suppression
- ◆ Amplitude modulation
- ◆ Pulse modulation
- ◆ Optional frequency and phase modulation (R&S®SM-B5)

### RF characteristics

- ◆ Wide output frequency range from 300 kHz to 6.4 GHz
- ◆ High (up to 16 dBm) and precise output level (<0.5 dB)
- ◆ Fast setting time for frequency (<3 ms) and level (<2.5 ms)<sup>1)</sup>
- ◆ Frequency hopping (500 μs)

- ◆ High spectral purity (typ. -130 dBc (1 Hz) at 1 GHz and 20 kHz carrier offset)
- ◆ Calibrated RF level in range from -140 dBm to -5 dBm
- ◆ RF, AF and level sweep (user-programmable)

### Special options

#### Fading Simulation R&S®SMIQB14/B15

- ◆ Fading of internal or external I/Q signals conforming to mobile radio standards
- ◆ 6-path simulation can be enhanced to 12-path simulation (2-channel fading also possible with second vector signal generator)
- ◆ Rayleigh, Rice and Lognormal fading profiles independently for each path selectable
- ◆ Selectable path attenuation and delay
- ◆ Simulation of high speeds
- ◆ Preprogrammed fading profiles for mobile radio standards GSM, NADC, IS-95 CDMA and TETRA
- ◆ Frequency range of basic unit can be fully utilized

#### Noise Generator and Distortion

##### Simulator R&S®SMIQB17

- ◆ Simulation of amplitude and phase distortion (AM/AM and AM/φM characteristics)
- ◆ Distortion characteristics programmable from up to 30 input values
- ◆ Superimposed noise signals (AWGN)
- ◆ C/N ratio variable with high resolution over a wide range
- ◆ Broad noise bandwidth (10 kHz to 10 MHz)

#### Bit Error Rate Measurements

##### R&S®SMIQB21

- ◆ Up to 30 MHz clock rate

#### WCDMA for 3GPP/FDD R&S®SMIQB45

Software option R&S®SMIQB45 supports the generation of downlink and uplink signals in line with the 3GPP standard (FDD mode). As the standardization process is not yet completed, the functionality of this option will continuously be adapted to the relevant standard modifications and expansions (for functionality see specifications).

#### Low ACP for IS-95 CDMA and WCDMA R&S®SMIQB47

- ◆ Specially designed for 1.2288 Mcps, 4.096 Mcps and 8.192 Mcps as well as 3.840 Mcps according to 3GPP
- ◆ Can be used with internal (option R&S®SMIQB42/43/45/48) or external CDMA/WCDMA signals
- ◆ Typical WCDMA adjacent-channel power ratio (5 MHz offset, 3.84 Mcps): -67 dBc (1 DPCH)
- ◆ Typical IS-95 CDMA adjacent-channel power ratio (885 kHz offset): -78 dBc (9 code channels)

#### Enhanced Functions for WCDMA 3GPP (FDD) Digital Standard R&S®SMIQB48

This option expands the functionality of option R&S®SMIQB45 WCDMA 3GPP. It allows the generation of up to four enhanced channels that can be combined with the standard channels.

- ◆ Very long signal sequences and continuous PRBS sequences (e.g. PN9) often required for BER measurements can be implemented for the channel under test

<sup>1)</sup> Without switching the mechanical attenuators.



Contents Overview

Chapter Overview

Type Index

R&amp;S Addresses





Contents Overview

Chapter Overview

Type Index

R&amp;S Addresses



## Vector Signal Generator R&S®SMIQ

- ◆ Use of externally precoded data or the generation of long power control profiles for the DUT
- ◆ Testing the closed-loop power control function of a mobile station
- ◆ Receiver and performance tests to TS 25.101, TS 25.104, TS25.141 and TS25.944
- ◆ Realistic simulation of WCDMA scenarios
- ◆ Creation and insertion of bit errors into the data of enhanced channels
- ◆ Insertion of block errors (BLERs) into the channel-coded data
- ◆ Generation of WCDMA signals of up to 2 minutes repetition rate

### Enhanced Fading Functions for W-CDMA 3GPP R&S®SMIQB49

Option R&S®SMIQB49 extends the functionality of fading options R&S®SMIQB14 /B15 to include WCDMA 3GPP channel simulation. It adds three new modes to the fading simulator so that all scenarios defined in 3GPP Release 99 can be simulated:

- ◆ In fine delay mode, fading simulator resolution is increased to 1 ns with up to four paths being available
- ◆ In moving delay mode, two paths are simulated: for one path the delay remains constant, whereas for the other path the delay varies continuously
- ◆ In birth-death mode, there are two paths changing delay in steps in accordance with the 3GPP channel model

### Digital Standard GPS R&S®SMIQB51

This option allows the static signal of a GPS satellite to be simulated. This enables the user to carry out basic GPS receiver testing. The most important

settings according to GPS standard can be activated on the R&S®SMIQ by a keystroke.

The data sources available are bit patterns of up to 16 bits in length and data lists. It is also possible to use navigation data. Several navigation data lists (i.e. 25 frames of GPS navigation data) can be generated by means of the free external "Almanac Uploader" PC software.

### TETRA T1 Simulator R&S®SMIQ-K8

R&S®SMIQ-K8 is a PC-based software package for generating TETRA T1, T2, T3, T1&T2 or T1&T3 test signals to ETS300-392/ETS300-394. It is designed for putting RF components into operation and supporting ETS300394-1 tests. R&S®SMIQ-K8 generates all the data sequences including all the control sequences required to operate the signal generator.

Characteristics:

- ◆ The TETRA frame (bit stream) is generated according to the selected burst type, i.e. control burst (CB), normal burst (NB) or synchronizing burst (SB)
- ◆ The frames are generated for the uplink (mobile station [MS] transmitting) and the downlink (base station [BS] transmitting)
- ◆ The channel types ACH, BSCH, BNCH, TCH, STCH and SCH are generated
- ◆ Channel coding is performed for all channels; scrambling with system code, base colour code, mobile country code and mobile network code can be set separately for each channel
- ◆ Frame repetition of 1 to 180 multi-frames can be selected via sequence length

- ◆ The T1 test signal is generated for the V + D (voice and data) test on MS and BS DUTs
- ◆ Channel types 1 to 4, 15 and 17 can be set for the downlink and channel types 7 to 11, 16 and 18 for the uplink
- ◆ The bit stream can be generated either from pseudo-random sequences (CCITT 0.153) or from user-selectable sequences
- ◆ The R&S®SMIQ-K8 software package calculates the appropriate TETRA T1 signal and transfers it to the R&S®SMIQ via the GPIB or RS-232-C interface; all the R&S®SMIQ settings that are needed are included. Additionally the R&S®SMIQ-K8 can operate a second R&S®SMIQ simultaneously for generating a TETRA T2 or T3 signal (TETRA T1, T2, T3, T1&T2 or T1&T3).

### Arbitrary Waveform Generator R&S®SMIQB60

To further enhance the versatility of the modulation coder, a dual-channel arbitrary waveform generator (ARB) with a maximum clock rate of 40 MHz is available as an option. It can store up to 512 ksamples of externally computed I/Q values.

The supplied R&S®WinIQSIM™ software (see page 263) allows the calculation of arbitrary modulation signals, for example COFDM, multicarrier and noise, and downloading them into R&S®SMIQ. Together with a convenient data editor, R&S®WinIQSIM™ can calculate any kind of TDMA frame configuration, simulate impairments by superimposed interference signals, etc.



Contents Overview

Chapter Overview

Type Index

R&amp;S Addresses





Contents Overview

Chapter Overview

Type Index

R&S Addresses



## Vector Signal Generator R&S®SMIQ

### Specifications in brief

You will find detailed and binding data on the enclosed CD (./DATASHEET/SMIQ.pdf), or, for the latest updates, visit [www.rohde-schwarz.com](http://www.rohde-schwarz.com), search term: **SMIQ**

#### Frequency

Range	R&S®SMIQ02B/03B/04B/06B	300 kHz to 2.2/3.3/4.4 GHz/6.4 GHz
<b>Level</b>		
Range	R&S®SMIQ02B/03B R&S®SMIQ04B/06B	-144 dBm to +13 dBm (PEP) -144 dBm to +10 dBm (PEP)
Overranging without warranty of specs		up to 16 dBm
Total level uncertainty	>-127 dBm	typ. <±0.5 dB (f ≤ 2 GHz)
Frequency response at 0 dBm		typ. <0.3 dB (f ≤ 3.3 GHz)
<b>Spectral purity</b>		
Spurious, harmonics at levels ≤ 10 dBm		<-30 dBc (R&S®SMIQ02B/03B)
Spurious, harmonics at levels ≤ 7 dBm		<-30 dBc (R&S®SMIQ04B/06B)
Broadband noise, carrier offset > 5 MHz, f > 450 MHz to 3040 MHz, CW		typ. -144 dBc
Broadband noise, vector modulation, (f > 20 MHz) carrier offset > 5 MHz		typ. -137 dBc
SSB phase noise, carrier offset 20 MHz, 1 Hz bandwidth f = 1 GHz	CW	Vector modulation (dig. modulation) <-126 dBc
<b>Sweep</b>		
RF sweep, AF sweep		digital sweep in discrete steps
Modes		automatic, single shot, manual or external trigger, linear or logarithmic

#### Modulation

<b>Internal modulation generator</b>		
Frequency range		0.1 Hz to 1 MHz
Vector modulation		2 inputs (I and Q)
Amplitude modulation <sup>2)</sup>		internal, external AC/DC
Broadband amplitude modulation		external DC
Pulse modulation		external
<b>Frequency modulation</b>	<b>Option R&amp;S®SM-B5</b>	int., external AC/DC, two-tone with two modulation channels FM1 and FM2
Max. deviation		0.5/1/2/4 MHz depending on frequency
<b>Phase modulation</b>	<b>Option R&amp;S®SM-B5</b>	int., external AC/DC, two-tone with two modulation channels φM1 and φM2
Max. deviation		5/10/20/40 rad depend. on frequency
<b>Digital modulation</b>	<b>Option R&amp;S®SMIQB20</b>	internal, external, serial, ext. parallel
<b>Predefined modulation settings</b>		
APCO C4FM, APCO QPSK, CDPD, CT2, DECT, GSM, IRIDIUM, NADC, PDC, PHS, TETRA, TETS, PWT, ICO BPSK, ICO GMSK, ICO QPSK, GSM/EDGE, CDMA IS-95, WCDMA, QPSK		
Envelope control		internal or external
Range of function		1 ksymbol/s to 2.5 Msymbol/s
Modulation modes		ASK, FSK, GMSK, PSK, QAM
ASK, symbol rate		100 symbol/s to 18 Msymbol/s
FSK, modulation modes		2FSK, 4FSK, 4FSK APCO, GFSK
GMSK, bit rate		100 bit/s to 7.5 Mbit/s <sup>1)</sup>
PSK, modulation modes		BPSK, QPSK, OQPSK, QPSK (IS-95), OQPSK (IS-95), QPSK (ICO), QPSK (INMARSAT), π/4DQPSK, π/4QPSK, 8PSK, 8PSK EDGE
QAM, modulation modes		16QAM, 32QAM, 64QAM, 256QAM

<b>Data generator</b>	<b>Option R&amp;S®SMIQB11</b>
Programmable data memory for modulation data, envelope-control and trigger signals. The data generator can be operated only in conjunction with the optional modulation coder	
Max. symbol rate	8.5 Msymbol/s
Operating modes	automatically repeating, single shot, manually or externally triggered
<b>Memory extension</b>	<b>Option R&amp;S®SMIQB12</b>
The data generator memory can be extended to max. 79 Mbit by fitting up to two options R&S®SMIQB12.	
Memory capacity	32 Mbit
<b>Digital standards</b>	<b>Options R&amp;S®SMIQB20/SMIQB11</b>
GSM/EDGE	according to GSM standard
DECT	according to ETS300175-2 and ETS300176-1
NADC	according to IS-54 and IS-136
PDC	according to RCR STD-27
PHS	according to RCR STD-28
<b>Digital standard IS-95 CDMA</b>	<b>Option R&amp;S®SMIQB42</b>
According to TIA standard IS-95A and J-STD-008	
<b>Digital standard WCDMA</b>	<b>Option R&amp;S®SMIQB43</b>
Modulation	QPSK, OQPSK
<b>Digital standard WCDMA 3GPP (FDD)</b>	<b>Option R&amp;S®SMIQB45<sup>3)</sup></b>
according to 3GPP standard 3.4.0 (FDD)	
3GPP (FDD) version	optional 3.4.0, according to technical specifications 3GPP TS25.211 and TS25.213
<b>Simultaneous modulation</b>	
Any combination is possible with the following exceptions:	
- Simultaneous FM and φM	
- Simultaneous digital modulation and vector modulation	
Pulse modulation cannot be used together with level attenuation function LEV ATT (option R&S®SMIQB20)	

#### Options for special applications

<b>Fading simulation</b>	<b>Options R&amp;S®SMIQB14/SMIQB15</b>
paths and channels with option R&S®SMIQB14	6 paths, 1 channel
with options R&S®SMIQB14/-B15	12 paths, 1 channel or 6 + 6 paths, 2 channels with second R&S®SMIQ through simple retrofit
Path attenuation	
Simulation types	Rayleigh fading, Rice fading, Lognormal fading, Suzuki fading
Correlation	paths 1 to 6 with paths 7 to 12
<b>Enhanced fading functions for WCDMA 3GPP</b>	<b>Option R&amp;S®SMIQB49</b>
The following data deviate from the specifications for R&S®SMIQB14/ R&S®SMIQB15	
Fine delay mode	
Number of paths	2 (with R&S®SMIQB14), 4 (with R&S®SMIQB14 + R&S®SMIQB15)
Profiles	Rayleigh, pure Doppler
Moving delay mode	
Number of paths	2
Birth-death mode	
Number of paths	2
Profiles	pure Doppler
<b>Noise and distortion simulation</b>	<b>Option R&amp;S®SMIQB17</b>
Distortion simulator	AM/AM and AM/φM distortion of modulation signal
Distortion characteristic	each characteristic programmable by entering up to 30 input values via IEC/IEEE bus or by entering up to five polynomial coefficients
Noise generator (AWGN)	
Distribution density	Gaussian, statistically indep. for I and Q



Contents Overview

Chapter Overview

Type Index

R&S Addresses





## Vector Signal Generator R&amp;S®SMIQ

<b>Bit error rate measurement</b>	<b>Option R&amp;S®SMIQB21</b>
Measurement time	selectable through maximum number of data bits or bit errors (max. 2 <sup>31</sup> bits each), continuous measurement
Measurement result	BER in ppm, % or decade values (if selected number of data bits or bit errors is attained) status displays: not synchronized, no clock, no data
<b>Improved adjacent-channel power ratio for WCDMA and CDMA IS-95</b>	<b>Option R&amp;S®SMIQB47</b>
Selectable baseband filters to improve ACP values (values see at Digital Standards CDMA/WCDMA)	
<b>Enhanced functions for digital standard WCDMA 3GPP (FDD)</b>	<b>Option R&amp;S®SMIQB48</b>
3GPP (FDD) version	3.4.0 to 3GPP technical specifications TS25.101, TS25.104, TS25.141, TS25.211 and TS25.213
<b>Enhanced Channels</b>	
Channels of W-CDMA system in R&S®SMIQ that offer enhanced functionality compared with standard channels of option R&S®SMIQB45. Can be used in downlink for max. four DPCHs and in uplink for one DPCC and max. three DPDCs. All DPCHs or DPDCs have the same symbol rate.	
Enhanced functions at a glance:	
Sequences of up to 1042 frames; data lists for data fields and TPC field; external power control; channel coding; bit error insertion; block error insertion; simulation of realistic noise scenarios; orthogonal channel noise simulation (OCNS); additional mobile stations	
<b>Digital Standard GPS</b>	<b>Option R&amp;S®SMIQB51</b>
Channels	1, simulation of one GPS satellite
Function:	
Simulation of static signal of GPS satellite using option SMIQB51; prerequisites: SMIQB11 (data generator) and SMIQB20 (modulation coder), SMIQ firmware version 5.65 or higher	
Navigation data:	
user-selectable bit patterns of up to 16 bit, user-definable data lists of any length, length only limited by memory capacity (SMIQB11, SMIQB12), simple generation of several navigation data lists of 37500 bits each, i.e. 25 frames of GPS navigation data, for example by means of free external PC software "AlmanacUploader", Application Note 1GP46	
<b>Arbitrary waveform generator</b>	<b>Option R&amp;S®SMIQB60</b>
Length of waveform	1 to 524216 in steps of one sample
Resolution	12 bit
Downloading time for 512k I/Q samples	4 s
Nonvolatile memory	
Number of blocks	22
Block size	24 from firmware version 5.30
Interpolation	65527
Signal output, channels	2 (I and Q)
Trigger modes	auto, retrig, armed auto, armed retrig
Trigger source	internal or external
Trigger outputs	2
Delay	0 to 524216 samples
On time, off time	1 to 524215 samples
<b>General data</b>	
Memory for instrument settings	50 storable settings
List Mode: Frequency and level values can be stored in a list and set in an extremely short time; permissible level variation: 90 dB	
Max. number of channels	2000
Remote control	IEC 625 (IEEE 488)
Power supply	90 V to 265 V (AC), 50 Hz to 400 Hz, autosearching to AC supply, max. 300 VA
Dimensions (W × H × D)	435 mm × 192 mm × 460 mm
Weight	25 kg when fully equipped

## Ordering information

<b>Vector Signal Generator</b>		
300 kHz to 2.2 GHz	R&S®SMIQ02B	1125.5555.02
300 kHz to 3.3 GHz	R&S®SMIQ03B	1125.5555.03
300 kHz to 4.4 GHz	R&S®SMIQ04B	1125.5555.04
300 kHz to 6.4 GHz	R&S®SMIQ06B	1125.5555.06
<b>Accessories supplied</b>	power cable, operating manual	
<b>Options</b>		
Reference Oscillator OCXO	R&S®SM-B1	1036.7599.02
FM/φM Modulator	R&S®SM-B5	1036.8489.02
Data Generator	R&S®SMIQB11	1085.4502.04
Memory Extension, 32 Mbit	R&S®SMIQB12	1085.2800.04
Fading Simulator, 6 paths	R&S®SMIQB14	1085.4002.02
Second Fading Simulator for 12 paths or 2 channels	R&S®SMIQB15	1085.4402.02
Noise Generator & Distortion Simulator	R&S®SMIQB17	1104.9000.02
RF and AF Rear Connectors	R&S®SMIQB19	1085.2997.02
Modulation Coder	R&S®SMIQB20	1125.5190.02
BER Measurement	R&S®SMIQB21	1125.5490.02
Digital Standard IS-95 CDMA	R&S®SMIQB42	1104.7936.02
Digital Standard WCDMA acc. to NTT DoCoMo 1.0, ARIB 0.0 standard	R&S®SMIQB43 <sup>2)</sup>	1104.8032.02
Digital Std. WCDMA acc. to 3GPP (FDD)	R&S®SMIQB45 <sup>1)</sup>	1104.8232.02
Low ACP for IS-95 CDMA and W-CDMA	R&S®SMIQB47	1125.5090.02
Extended Functions for WCDMA (3GPP)	R&S®SMIQB48	1105.0587.02
Ext. Fading Funct. for WCDMA (3GPP)	R&S®SMIQB49	1105.1083.02
Digital Standard GPS	R&S®SMIQB51	1105.1683.02
Arbitrary Waveform Generator incl. R&S®WinIQSIM™	R&S®SMIQB60	1136.4390.02
TETRA T1 Simulator	R&S®SMIQ-K8	1136.4290.02
<b>Software for R&amp;S®SMIQB60</b>		
Digital Standard IS-95 CDMA	R&S®SMIQK11	1105.0287.02
Digital Standard cdma2000	R&S®SMIQK12	1105.0435.02
Dig. Std. WCDMA TDD mode (3GPP)	R&S®SMIQK13	1105.1231.02
Digital Standard TD-SCDMA	R&S®SMIQK14	1105.1338.02
OFDM Signal Generation, HIPER LAN/2	R&S®SMIQK15	1105.1531.02
Digital Standard 1xEV-DO	R&S®SMIQK17	1154.7800.02
Digital Standard IEEE 802.11	R&S®SMIQK19	1154.8307.02
Digital Std. 3GPP FDDA incl. HSDPA	R&S®SMIQK20	on request

Additional hint: R&S®SMIQ02B/03B (R&S®SMIQ04B/06B) can be equipped with up to three (two) of the following options: R&S®SM-B5, R&S®SMIQB14, R&S®SMIQB15, R&S®SMIQB17

**Application software**

Generation of Data and Control Lists	R&S®SMIQ-K1	1)
Bluetooth signals for R&S®SMIQ	R&S®SMIQ-K5	1)
User mappings and user filters for R&S®SMIQ	User Mod	1)
IQWizard <sup>1)</sup>		1)

<sup>1)</sup> available on [www.rohde-schwarz.com](http://www.rohde-schwarz.com)

**Extras**

19" Adapter	R&S®ZZA-94	0396.4905.00
Service Kit	R&S®SM-Z3	1085.2500.02
BNC Adapter for rear panel, D type connector PAR DATA	R&S®SMIQ-Z5	1104.8555.02
90° Power Splitter	R&S®SMIQ-Z9	1104.9580.02
Trolley for Transit Case	R&S®ZZK-1	1014.0510.00
Transit Case	R&S®ZZK-944	1013.9366.00
Service Manual R&S®SMIQ		1085.2445.24

## Vector Signal Generator R&S® SMIQ03HD

2110 MHz to 2170 MHz

Dedicated to 3GPP,

special model of Vector Signal

Generator R&S® SMIQ

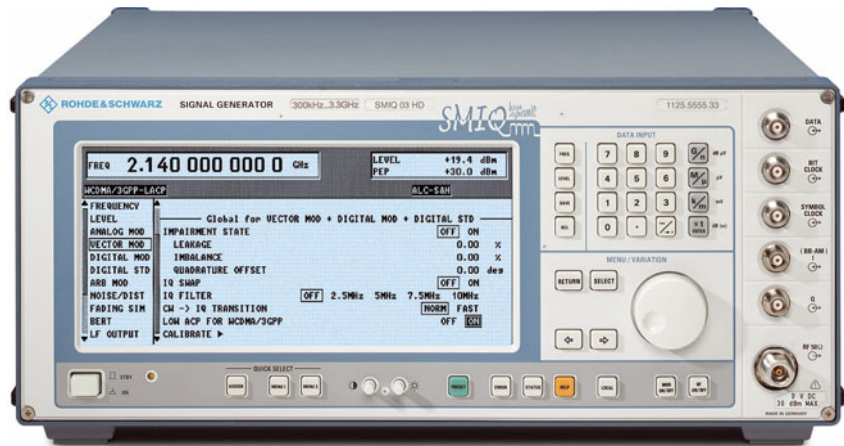

### Brief description

The signal statistics of a WCDMA signal reveal high crest factors (peak-to-average power ratios). Therefore, amplifiers with a wide linear range are required to ensure distortion-free transmission not only of average transmit power but also of high power peaks.

The requirements on base station power amplifiers become even more stringent since the amplifiers also transmit multicarrier signals within the 60 MHz downlink band. In addition to single-carrier power amplifiers (SCPAs), multicarrier power amplifiers (MCPAs) are increasingly used. Signal sources featuring wide

dynamic range and high accuracy, such as the R&S® SMIQ03HD, are required for the development and production testing of the amplifiers. WCDMA specifications allow base stations only a very low adjacent-channel power (ACP).

SCPA	Description	Type	Order No.
Internal baseband generation	<b>Vector Signal Generator</b>	R&S® SMIQ03HD	1125.5555.33
	Modulation Coder	R&S® SMIQB20	1125.5190.02
	Data Generator	R&S® SMIQB11	1805.4502.04
	Digital Standard WCDMA 3GPP (FDD)	R&S® SMIQB45	1104.8232.02
Ext. baseband generation (e.g. using R&S® AMIQ)	High ACLR for WCDMA 3GPP	R&S® SMIQB57	1105.1831.02
	<b>Vector Signal Generator</b>	R&S® SMIQ03HD	1125.5555.33
	High ACLR for WCDMA 3GPP	R&S® SMIQB57	1105.1831.02
	I/Q Modulation Generator, incl. R&S® WinIQSIM™	R&S® AMIQ	1110.2003.04

MCPA	Description	Type	Type	Order No.
Internal baseband generation	<b>Vector Signal Generator</b>	R&S® SMIQ03HD	Multicarrier signals with one R&S® SMIQ03HD	Multicarrier signals with two or more R&S® SMIQ03HD externally combined
	Modulation Coder	R&S® SMIQB20	R&S® SMIQB20	R&S® SMIQB20
	Data Generator	R&S® SMIQB11	R&S® SMIQB11	R&S® SMIQB11
	Digital Standard WCDMA 3GPP FDD	–	R&S® SMIQB45 <sup>1)</sup>	R&S® SMIQB45 <sup>1)</sup>
	High ACLR for WCDMA 3GPP	–	R&S® SMIQB57	R&S® SMIQB57
	Arbitrary Waveform Generator incl. R&S® WinIQSIM™	R&S® SMIQB60	–	–
Ext. baseband generation (e.g. using R&S® AMIQ)	<b>Vector Signal Generator</b>	R&S® SMIQ03HD	R&S® SMIQ03HD	1125.5555.33
	I/Q Modulation Generator, incl. R&S® WinIQSIM™	R&S® AMIQ	R&S® AMIQ	1110.2003.04

<sup>1)</sup> Alternatively WCDMA 3GPP FDD signals can be generated with the option R&S® SMIQB60 (1136.4390.02) and R&S® WinIQSIM™



Contents Overview

Chapter Overview

Type Index

R&S Addresses



## Vector Signal Generator R&S®SMIQ03HD

The R&S®SMIQ03HD supplies a test signal whose adjacent-channel leakage ratio (ACLR) is much better than the one required for base stations so that measurements can be carried out on amplifiers with sufficient dynamic range.

### Main features

- ◆ Wide dynamic range: ACLR typ. 70 dB for 3GPP test model 1/64
- ◆ Single-carrier scenarios: further improvement of ACLR (typ.77 dB) with option R&S®SMIQB57. Band-specific solution (3GPP downlink) combined with high output power (up to +30 dBm PEP)
- ◆ Multicarrier scenarios: integrated baseband filters to improve ACLR for 1 to 4 W-CDMA carriers
- ◆ Optional fading simulator (R&S®SMIQB14/B15) and noise generator/distortion simulator (R&S®SMIQB17)
- ◆ Short frequency and level setting time

### Specifications in brief

**You will find detailed and binding data on the enclosed CD (./DATASHEET/SMIQ03HD.pdf), or, for the latest updates, visit [www.rohde-schwarz.com](http://www.rohde-schwarz.com), search term: SMIQ03HD**

For general data please refer to the R&S®SMIQ standard data sheet (PD 0757.2438). The following data differs from the standard data or pertains to additional features.

#### Digital Standard WCDMA 3GPP (FDD) (option R&S®SMIQB45)

Single-carrier measurements (low-noise output mode)	
ACLR (1850 MHz to 2200 MHz, level ≤8 dBm (PEP))	
1 DPCH (crest factor 5.4 dB, I/Q filter 2.5 MHz, offset 10 MHz)	typ. 76 dB
Test model 1, 64 DPCH (crest factor 10.6 dB, I/Q filter 2.5 MHz, offset 10 MHz)	typ. 73 dB
ACLR	
1 DPCH (crest factor 5.4 dB, average power ≤10 dBm, offset 10 MHz)	typ. 84 dB
Test model 1, 64 DPCH (crest factor 10.6 dB, average power ≤10 dBm, offset 10 MHz)	typ. 82 dB
Multicarrier measurements (low-noise output mode)	
ACLR (2110 MHz to 2170 MHz, level ≤8 dBm (PEP); multicarrier signals generated with the internal Arbitrary Waveform Generator R&S®SMIQB60)	
2 carriers, test model 1, 64 DPCH (crest factor 11 dB, I/Q filter 5 MHz, offset 10 MHz)	typ. 68 dB
3 carriers, test model 1, 64 DPCH (crest factor 11.3 dB, I/Q filter 7.5 MHz, offset 10 MHz)	typ. 65 dB
4 carriers, test model 1, 64 DPCH (crest factor 11.8 dB, I/Q filter 10 MHz, offset 10 MHz)	typ. 64 dB

#### High ACLR for WCDMA 2110 MHz to 2170 MHz (option R&S®SMIQB57)

Frequency range	2110 MHz to 2170 MHz
3GPP channel bandwidth	3.84 MHz
Level	
Output level (PEP), normal output mode	-130 dBm to 27 dBm
Overrange	30 dBm
Uninterrupted level setting (attenuator mode fixed)	>30 dB
Repeatability (ALC STATE ON (CW mode))	typ. 0.05 dB
Linearity error (in displayed level range, attenuator mode fixed)	typ. 0.1 dB

Total level uncertainty	
Attenuator mode auto (-120 dBm to 25 dBm (PEP))	
CW	<0.5 dB
Digital modulation	<0.7 dB
Spectral purity	
Harmonics	
Level <25 dBm (PEP)	<-30 dBc, typ. -40 dBc
Level <15 dBm (PEP)	<-40 dBc, typ. -50 dBc
Nonharmonics, carrier offset >10 kHz	<-86 dBc
Subharmonics	none
Error vector magnitude (W-CDMA, 3.84 Mcps), rms	typ. 4%

#### Restrictions on other data when using option R&S®SMIQB57

**General:** Modulation bandwidth is reduced to 3GPP channel bandwidth. Due to steep bandpass filtering, additional amplitude and group delay distortions occur.

Topic concerned	Remark
- Broadband amplitude modulation	-
- Digital modulation	Increased EVM at higher symbol rates
- Digital Standard IS-95 CDMA R&S®SMIQB42	850 kHz I/Q filter not provided
- Digital Standard WCDMA R&S®SMIQB43, Digital Standard WCDMA 3GPP (FDD) R&S®SMIQB45, Enhanced Functions for Digital Standard WCDMA 3GPP (FDD) R&S®SMIQB48	Increased EVM
- Arbitrary Waveform Generator R&S®SMIQB60	-
- Fading Simulators R&S®SMIQB14/15	-
- Noise Generator/Distortion Simulator R&S®SMIQB17	-
- Amplitude modulation	Not possible with R&S®SMIQB57
- Level setting, attenuator mode electronic	Not possible with R&S®SMIQB57
- Level setting, ALC OFF, MODE TABLE	Not possible with R&S®SMIQB57

### Ordering information

<b>Vector Signal Generator</b>	R&S®SMIQ03HD	1125.5555.33
<b>Accessories supplied</b>	power cable, operating manual	
<b>Option</b>		
High ACLR for WCDMA 3GPP	R&S®SMIQB57 <sup>1)</sup>	1105.1831.02

<sup>1)</sup> Factory installation only.



Contents Overview

Chapter Overview

Type Index

R&S Addresses





Contents Overview

Chapter Overview

Type Index

R&amp;S Addresses



## Vector Signal Generator R&S®SMV03

9 kHz to 3.3 GHz

Vector modulation in the  
analog class



### Brief description

The Vector Signal Generator R&S®SMV03 is based on the successful analog Signal Generator R&S®SML03 and so features the same excellent technical characteristics. It comprises an additional broadband I/Q modulator which is able to generate any digital signal in conjunction with an external I/Q source. The R&S®SMV03 is, therefore, a way of entering the wide field of automatic test systems as well as gaining access to applications like R&D and service. When used together with R&S®AMIQ and R&S®WinIQSIM™, the R&S®SMV03 can generate digital signals that meet any requirement.

### Main features

#### RF characteristics

- ◆ Frequency range from 9 kHz to 3.3 GHz with 0.1 Hz resolution
- ◆ High output level of +13 dBm with a deviation <0.5 dB
- ◆ Interruption-free level setting by electronic attenuator
- ◆ High spectral purity (<-122 dBc (1 Hz) at f = 1 GHz with 20 kHz carrier offset)
- ◆ Frequency and level setting time <10 ms

#### Vector modulation

- ◆ Wide I/Q bandwidth of >50 MHz (3 dB), 100 MHz RF bandwidth for f >500 MHz to 3 GHz
- ◆ High vector accuracy

#### Analog modulation

- ◆ AM/FM/ϕM as standard
- ◆ Simultaneous AM, FM/ϕM, pulse and vector modulation
- ◆ Optional pulse modulator with integrated pulse generator (R&S®SML-B3)

#### Size

- ◆ Compact size
- ◆ Low weight <9.5 kg

#### User friendly

- ◆ One-hand operation with EasyWheel
- ◆ Settings simple and self-explanatory
- ◆ High-contrast LCD
- ◆ User-assignable menu keys
- ◆ Online help including IEC/IEEE-bus commands

#### Low Cost of Ownership

- ◆ 3-year calibration cycle
- ◆ Electronic attenuator for wear-free operation
- ◆ Service-friendly (continuous selftest, access to internal test points)

#### Production: fast, accurate, reliable

#### Versatility

The R&S®SMV03 generates all kinds of I/Q-modulated signals using the integrated vector modulator. Thanks to its wide bandwidth of 50 MHz, the R&S®SMV03 is also optimally suited for applications using high data rates such as WLAN standards. Signals to digital

standards can be easily generated in conjunction with an external I/Q source like the Modulation Generator R&S®AMIQ and the associated R&S WinIQSIM™ simulation software.

#### Dimensions

The compact size (only 2 HU) makes the R&S®SMV03 ideal for use in production where space is often limited.

#### Speed

Speed is essential – especially in production. And this is exactly where the R&S®SMV03 shows what it can do with a frequency and level setting time of <10 ms.

#### Accuracy

Any measurement uncertainty has two components: the uncertainty due to the measuring instrument and that due to the rest of the test setup. The lower the level uncertainty of the vector signal generator, the greater the test setup tolerance that may be allowed. If greater tolerances can be allowed for the DUT because of the small level error of the R&S®SMV03, production rejects can be markedly reduced – an advantage that pays off immediately.

#### Reliability

A signal generator used in production must feature high reliability. The R&S®SMV03 meets this requirement for example through the use of a completely wear-free electronic attenuator.



Contents Overview

Chapter Overview

Type Index

R&amp;S Addresses





## Vector Signal Generator R&S®SMV03

### Output level

In production test systems, the signal is routed to the DUT via switches and cables which introduce losses. This can be compensated for by the high output power of the R&S®SMV03.

### Lab and R&D: versatile

#### Versatile modulation modes

Particularly in research, a great variety of digital signals are used in the development of new systems, which are not always covered by a standard. Thanks to its very wideband I/Q modulator, the R&S®SMV03 can handle universal tasks of this kind.

Also, the vector signal generator, in conjunction with the optional Pulse Modulator R&S®SML-B3, can handle all types of analog modulation. AM, FM/φM and pulse modulation can be used simultaneously as can vector modulation, FM/φM and pulse modulation.

#### High spectral purity

Thanks to its low phase noise R&S®SMV03 is ideally suited to replace LOs.

#### High and accurate output level

The high level accuracy of the Vector Signal Generator R&S®SMV03 is a prerequisite for highly accurate measurements on sensitive analog and digital receivers. Its high output level makes the R&S®SMV03 an ideal source for driving high-level mixers.

*Typical SSB phase noise at 1 GHz  
(with OCXO option R&S®SML-B1)*

### Servicing: robust, compact, lightweight

#### Mobility

R&S®SMV03 is lightweight (<9.5 kg) and compact and therefore very easy to transport.

#### Flexible control

In service environments, an IEC/IEEE interface is not always available to control the generator. This is not a problem as the R&S®SMV03 can also be controlled via a standard RS-232-C interface.

#### Protection against overvoltage

The integrated overvoltage protection of the RF output protects the R&S®SML against very high external voltages such as may occur during transceiver measurements.

### EMS measurements

#### Interruption-free level setting without overshoots

EMS measurements require interruption-free level setting which should also be overshoot-free. The R&S®SMV03 does not produce any overshoots – even at setting times <10 ms. Furthermore, it has a wide dynamic range of typ. 30 dB over which level adjustment is interruption-free.

#### Wide frequency range

R&S®SMV03 features a lower frequency limit of 9 kHz as standard and so fully covers the frequency range required for EMC measurements.

#### Reference source

R&S®SMV03 allows selection of the mode of frequency generation. In the Extended Divider Range mode, the RF signal is generated by frequency division. The excellent values obtained in this mode for SSB phase noise are comparable to those from the high-grade crystal oscillators normally used as reference sources from 10 MHz to 30 MHz.

### Stereo/RDS Coder R&S®SML-B5 (option)

Fitted with the new option, the signal generators of the tried and tested R&S®SML and R&S®SMV families generate stereo-modulated RF signals to standard for use in production, development and service. At the core of this option is a digital signal processor (DSP) that generates stereo, RDS and ARI signals of outstanding quality, which is fully sustained owing to the excellent FM modulators in the generators.

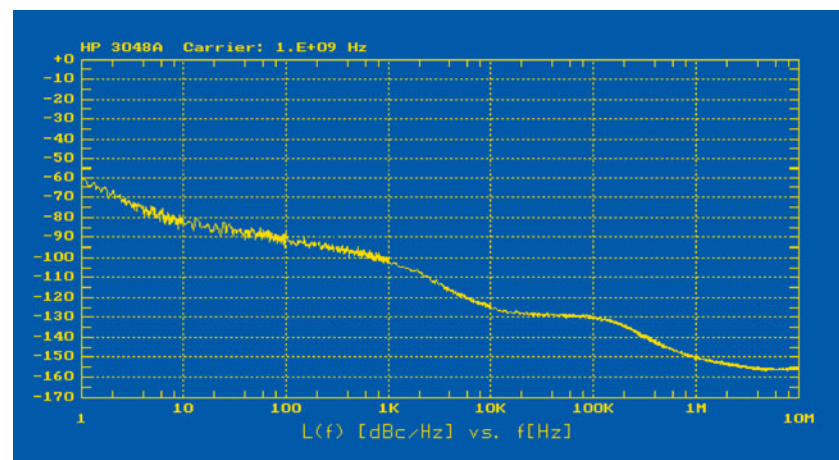



## Vector Signal Generator R&amp;S®SMV03

## Specifications in brief

You will find detailed and binding data on the enclosed CD (./DATASHEET/SMV03.pdf), or, for the latest updates, visit [www.rohde-schwarz.com](http://www.rohde-schwarz.com), search term: SMV03

Frequency	
I/Q modulation off	9 kHz to 3.3 GHz
I/Q modulation on	5 MHz to 3.3 GHz
Resolution	0.1 Hz
Spectral purity	
Harmonics spurious signals <sup>1)</sup>	
f ≤ 20 kHz	<−25 dBc at levels ≤ +8 dBm
f > 20 kHz	<−30 dBc at levels ≤ +8 dBm
Subharmonics spurious signals	
f ≤ 1.1 GHz	–
f > 1.1 GHz	<−50 dBc
Nonharmonics spurious signals (carrier offset > 10 kHz)	
f ≤ 1.1 GHz	<−70 dBc
f > 1.1 GHz to 2.2 GHz	<−64 dBc
f > 2.2 GHz to 3.3 GHz	<−58 dBc
Broadband noise <sup>2)</sup> (f = 1 GHz, carrier offset > 2 MHz, 1 Hz bandwidth)	<−140 dBc, typ. −150 dBc
SSB phase noise (f = 1 GHz, 20 kHz carrier offset, 1 Hz bandwidth)	<−122 dBc, typ. −128 dBc
Spurious FM, rms (f = 1 GHz)	
0.3 kHz to 3 kHz	typ. <4 Hz, 1 Hz
0.03 kHz to 20 kHz	typ. <10 Hz, 3 Hz
Spurious AM, rms	
0.03 kHz to 20 kHz	<0.02%
Level	
Range	−140 dBm to +13 dBm <sup>2)</sup> (overrange +19 dBm)
Resolution	0.1 dB
Level accuracy <sup>2)</sup> <sup>3)</sup> (level > −120 dBm)	
100 kHz to ≤ 2 GHz	<0.5 dB
Frequency response at 0 dBm <sup>2)</sup> <sup>3)</sup>	
100 kHz to ≤ 2 GHz	<0.7 dB
Setting time (IEC/IEEE bus), f > 100 kHz	<10 ms, typ. 5 ms
Interruption-free level setting <sup>4)</sup>	
I/Q modulation off	20 dB, overrange 30 dB
I/Q modulation on	15 dB, overrange 20 dB
Overvoltage protection	
safeguards unit against externally applied RF power and DC voltage (50 Ω source)	
Max. permissible RF power (f ≤ 2.2 GHz)	50 W
Max. permissible DC voltage	35 V
Sweep	
digital in discrete steps	
RF sweep, AF sweep	
automatic, single-shot, manually or externally triggered, linear or logarithmic	
Sweep range	user-selectable
Step width (lin)	user-selectable
Step width (log)	0.01% to 100%
Level sweep	
automatic, single-shot, manually or externally triggered, logarithmic	
Sweep range	user-selectable
Step width (log)	user-selectable
Step time/resolution	10 ms to 1 s/0.1 ms

<b>Vector Modulation</b>	external DC
I and Q modulation inputs	<1.2
Input voltage for full-scale level	$\sqrt{I^2 + Q^2} = 0.5 \text{ V}$ (1 V into 50 Ω)
Static error vector <sup>5)</sup> , level < +8 dBm	
Rms value	<0.5%
Peak value	<1%
Modulation frequency response	
f > 500 MHz to 3 GHz, DC to 5 MHz	<0.4 dB
Residual carrier at 0 V input voltage referred to max. input voltage	
	<−45 dBc
I/Q imbalance	
Carrier leakage (setting range)	0% to 50%
I≠Q (setting range)	−12% to +12%
Quadrature offset (setting range)	−10° to +10°
Adjacent-channel power	
WCDMA 3GPP FDD (f = 2.14 GHz)	
Test model 1 (64 DPCHs), offset 10 MHz	typ. −66 dBc
Internal modulation generator	
Frequency range; resolution	0.1 Hz to 1 MHz; 0.1 Hz
Frequency response (up to 500 kHz, level > 100 mV)	
	<0.5 dB
THD (< 100 kHz, level 4 V, 600 Ω)	<0.1%
Open-circuit voltage V <sub>o</sub> (LF connector)	1 mV to 4 V
Frequency setting time (after reception of last IEC/IEEE-bus character)	
	<10 ms
Simultaneous modulation	
	AM, FM/ϕM and pulse modulation or vector modulation, FM/ϕM and pulse modulation
Amplitude modulation <sup>6)</sup>	
	internal, external AC/DC, internal/external two-tone
Modulation depth	
	0% to 100%
settable modulation depth continuously decreasing between +7 dBm and +13 dBm <sup>7)</sup> while adhering to AM specifications; a status message is output when the modulation depth is too high	
Modulation frequency range (< 3 dB)	
	DC/10 Hz to 50 kHz
Setting accuracy at 1 kHz (m < 80%) <sup>8)</sup>	
	<4% of reading + 1%
AM distortion at 1 kHz	
m = 30%	<1%
m = 80%	<2%
Incidental ϕM at AM (30%), AF = 1 kHz	
	<0.2 rad
Frequency modulation	
	internal, external AC/DC, internal/external two-tone
Frequency deviation	
9 kHz to 76 MHz	0 Hz to 1 MHz
> 76 MHz to 151.3125 MHz	0 Hz to 125 kHz
> 151.3125 MHz to 302.625 MHz	0 Hz to 250 kHz
> 302.625 MHz to 605.25 MHz	0 Hz to 500 kHz
> 605.25 MHz to 1.2105 GHz	0 Hz to 1 MHz
> 1.2105 GHz to 1.818 GHz	0 Hz to 2 MHz
> 1.818 GHz to 2.655 GHz	0 Hz to 3 MHz
> 2.655 GHz to 3.300 GHz	0 Hz to 4 MHz
Setting accuracy (at AF = 1 kHz)	
	<4% of reading + 20 Hz
FM distortion (at AF = 1 kHz and 50% of max. deviation)	
	<0.2%, 0.1% typ.
Modulation frequency range (< 3 dB)	
standard	DC to 100 kHz
wide	10 Hz to 500 kHz
Incidental AM (at AF = 1 kHz, f > 10 MHz, 40 kHz deviation)	
	<0.1%



Contents Overview

Chapter Overview

Type Index

R&amp;S Addresses



## Vector Signal Generator R&amp;S®SMV03

Stereo modulation at 40 kHz useful deviation, AF = 1 kHz, RF = 87 to 108 MHz	
Crosstalk	>50 dB
S/N ratio unweighted, rms	>70 dB
S/N ratio weighted, rms	>70 dB
Carrier frequency offset at FM DC	typ. 0.1% of set deviation
Modulation input EXT	1 V
<b>Phase modulation</b>	internal, external AC/DC, internal/external two-tone
Phase deviation <sup>9)</sup>	
9 kHz to 76 MHz	0 rad to 10 (2) rad
>76 MHz to 151.3125 MHz	0 rad to 1.25 (0.25) rad
>151.3125 MHz to 302.625 MHz	0 rad to 2.5 (0.5) rad
>302.625 MHz to 605.25 MHz	0 rad to 5 (1) rad
>605.25 MHz to 1.2105 GHz	0 rad to 10 (2) rad
>1.2105 GHz to 1.818 GHz	0 rad to 20 (4) rad
>1.818 GHz to 2.655 GHz	0 rad to 30 (6) rad
>2.655 GHz to 3.300 GHz	0 rad to 40 (8) rad
Modulation frequency range (–3 dB) standard	DC to 100 kHz
wide	10 Hz to 500 kHz
Resolution	<1%, min. 0.001 rad
Setting accuracy at AF = 1 kHz	<4% of reading + 0.02 rad
Phase distortion (at AF = 1 kHz and 50% of maximum deviation)	<0.2%, typ. 0.1%
<b>Pulse modulation (option SML-B3)</b>	internal, external
On/off ratio	>90 dB
Rise/fall time (10%/90%)	<20 ns, typ. 10 ns
Pulse repetition frequency	0 Hz to 2.5 MHz
Pulse delay	typ. 50 ns
Video crosstalk (V <sub>o</sub> )	<30 mV
<b>Pulse generator (option SML-B3)</b>	automatic, externally triggered, external gate mode, single pulse, double pulse, delayed pulse (externally triggered)
Active trigger edge	positive or negative
Pulse period/resolution/accuracy	100 ns to 85 s/5 digits/<1 × 10 <sup>-4</sup>
Pulse width/resolution/accuracy	20 ns to 1 s/4 digits/<1 × 10 <sup>-4</sup> + 3 ns
Pulse delay/resolution/accuracy	20 ns to 1 s/4 digits/<1 × 10 <sup>-4</sup> + 3 ns
Double-pulse spacing/resol./accuracy	20 ns to 1 s/4 digits/<1 × 10 <sup>-4</sup> + 3 ns
Trigger delay	typ. 50 ns
Jitter	<10 ns
<b>Stereo/RDS Coder (with option R&amp;S®SML-B5)</b>	
The specifications apply to RF frequencies in the range 66 MHz to 110 MHz.	
Stereo modes	
Internal with modulation generator	L, R, R = L, R = –L
External analog (via L and R inputs) or external digital (via S/P DIF input)	L, R, R = L, R = –L, R ≠ L
	internal generation of ARI/RDS signals, 5 user-selectable RDS data sets, simultaneous generation of MPX, ARI and RDS signals possible
MPX frequency deviation	0 Hz to 80 kHz
L, R signal	
AF frequency range	20 Hz to 15 kHz
AF frequency response (referenced to 500 Hz, 40 Hz to 15 kHz)	<0.2 dB
Stereo crosstalk attenuation (1 kHz)	>50 dB
Distortion (at 67.5 kHz MPX frequency deviation, AF = 1 kHz)	<0.1%, typ. 0.05%
S/N ratio <sup>10)</sup> (stereo/RDS signal)	
ITU-R weighted (quasi-peak)	>60 dB, typ. 63 dB
ITU-R unweighted (rms)	>70 dB, typ. 74 dB
A-weighted (rms)	>70 dB, typ. 76 dB.
Preemphasis	off, 50 μs, 75 μs

Pilot tone	
Frequency	19 kHz ±2 Hz
Deviation	0 Hz to 10 kHz
Phase (relative to 38 kHz phase)	0° to ±5°
ARI/RDS subcarrier frequency	57 kHz ±6 Hz
ARI frequency deviation	0 Hz to 10 kHz
RDS frequency deviation	0 Hz to 10 kHz
ARI/RDS	functions (directly selectable by menu or remote control)
ARI identification	selection of traffic announcement identification (DK) or area identification (BK), OFF, DK, BK, DK + BK
ARI BK	selection of standardized area identification A to F
RDS traffic program	traffic program off/on
RDS traffic announcement	traffic announcement off/on
RDS data set	selection of RDS data set 1 to 5
Maximum data length	64 kByte, can be loaded via IEC60625 or RS-232-C interface

- 1) With option R&S®SML-B3 only for f > 20 MHz.
- 2) With Attenuator Mode Auto.
- 3) Temperature range 20°C to 30°C.
- 4) With Attenuator Mode Fixed.
- 5) After 1 hour warm-up and recalibration within 4 hours of operation after temperature variations <5°C.
- 6) With Attenuator Mode Auto, f ≥ 100 kHz.
- 7) R&S®SML02, R&S®SML03: +5 dBm to 11 dBm at f ≤ 5 MHz, f > 3 GHz.
- 8) With option R&S®SML-B3 only for f > 10 MHz.
- 9) Values in brackets apply to wide modulation bandwidth.
- 10) Generator without preemphasis, receiver with deemphasis.

## General data

Memory for device settings	100 storable settings
Remote control	IEC625 (IEEE 488) and RS-232-C
Rated temperature range	0°C to 55°C;
Power supply	100 V to 120 V (AC), 50 Hz to 400 Hz, 200 V to 240 V (AC), 50 Hz to 60 Hz, autoranging, max. 250 VA
Dimensions (W × H × D)	427 mm × 88 mm × 450 mm
Weight	9.5 kg when fully equipped

## Ordering information

<b>Vector Signal Generator</b>	R&S®SMV03	1147.7509.13
Accessories supplied	power cable, user manual	
<b>Options</b>		
Reference Oscillator OCXO	R&S®SML-B1	1090.5790.02
Pulse Modulator	R&S®SML-B3	1090.5403.02 <sup>1)</sup>
Stereo /RDS Coder	R&S®SML-B5	1147.8805.02
Rear Connectors for AF, RF	R&S®SML-B19	1090.5303.02 <sup>1)</sup>
<b>Extras</b>		
Service Kit	R&S®SML-Z2	1090.5203.02
19" Rack Adapter	R&S®ZZA-211	1096.3260.00
Transport Bag	R&S®ZZT-214	1109.5119.00
Service Manual, Modules		1090.3123.24

- 1) Factory-fitted only.



Contents Overview

Chapter Overview

Type Index

R&amp;S Addresses





Contents Overview

Chapter Overview

Type Index

R&amp;S Addresses



## Signal Generator R&amp;S®SMT

R&amp;S® SMT02: 5 kHz to 1.5 GHz

R&amp;S® SMT03: 5 kHz to 3 GHz

R&amp;S® SMT06: 5 kHz to 6 GHz

For receiver and EMS

measurements

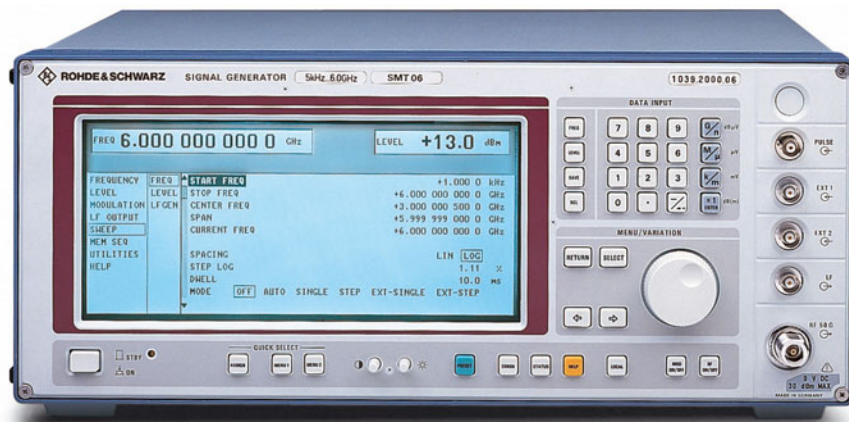
*Signal Generator R&S®SMT*

## Brief description

Signal Generator R&S®SMT covers the complete range of conventional analog receiver measurements. It provides an exceptionally high signal quality for a generator in this price category, as well as outstanding level accuracy, a wide variety of modulation and signal generation modes, customized configuration, and great ease of operation. Features such as programmable RF, LF and level sweeps as well as the correction of external frequency response make the R&S®SMT an ideal source for EMS measurements.

## Main features

- ◆ Ideal EMS signal source with specified frequency range from 5 kHz
- ◆ AM, FM,  $\phi$ M, pulse modulation
- ◆ FM DC with high carrier frequency accuracy
- ◆ Broadband FM from DC to 8 MHz, broadband  $\phi$ M from DC to 2 MHz

- ◆ Convenient RF/LF/level sweep
- ◆ Programmable level correction (compensation of external frequency response)
- ◆ VOR/ILS generator (option R&S®SM-B6)
  - phase resolution 0.01°
  - DDM resolution 0.0001
- ◆ Stereo generator (option R&S®SM-B6) for measurements on FM sound broadcast transmitters and receivers
- ◆ Large, backlit LCD for clear display of all relevant settings
- ◆ Minimum RF leakage due to special shielding measures
- ◆ Calibration interval of three years

## Overview of options

Designation, functions	Option
<b>Reference Oscillator OXC0:</b> aging $<1 \times 10^{-9}$ /day	R&S®SM-B1
<b>LF Generator:</b> supplies sinewave, noise 0.1 Hz to 500 kHz, triangular, squarewave 0.1 Hz to 50 kHz signals	R&S®SM-B2
<b>Pulse Modulator:</b> on/off ratio >80 dB, rise/fall time <10 ns	R&S®SMT02: R&S®SM-B3 R&S®SMT03: R&S®SM-B8 R&S®SMT06: R&S®SM-B9
<b>Pulse Generator:</b> only in conjunction with R&S®SM-B3/R&S®SM-B8/R&S®SM-B9; provides single, delayed and double pulses	R&S®SM-B4
<b>Multifunction Generator:</b> produces stereo multiplex and VOR/ILS signals as well as sinewave, noise 0.1 Hz to 1 MHz, triangular, sawtooth, squarewave 0.1 Hz to 50 kHz signals	R&S®SM-B6
<b>Rear Connectors for RF and LF:</b> to replace front-panel connectors	R&S®SMT-B19



Contents Overview

Chapter Overview

Type Index

R&amp;S Addresses





## Signal Generator R&amp;S® SMT

## Specifications in brief

You will find detailed and binding data on the enclosed CD (./DATASHEET/SMT.pdf), or, for the latest updates, visit [www.rohde-schwarz.com](http://www.rohde-schwarz.com), search term: SMT

<b>Frequency</b>	
Range R&S® SMT02/03/06	5 kHz to 1.5/3/6 GHz
Phase offset	adjustable in 1° steps
<b>Spectral purity</b>	
Spurious signals	
Harmonics	<-30 dBc, with R&S® SM-B8/-B9: <-26 dBc
Nonharmonics (f < 1.5 GHz)	<-80 dBc
SSB phase noise at 20 kHz from carrier, 1 Hz bandwidth	
<67.5 MHz/125 MHz	<-120 dBc/<-134 dBc
250 MHz/500 MHz	<-128 dBc/<-122 dBc
1000 MHz/2000 MHz	<-116 dBc/<-110 dBc
3000 MHz/6000 MHz	<-109 dBc/<-103 dBc
<b>Level</b>	-144 to +13 dBm
Accuracy for levels >=127 dBm	
f < 1.5 GHz	±1 dB
Level frequency response at 0 dBm	1 dB, typ. 0.3 dB
<b>Simultaneous modulation</b>	
	any combination of AM, FM (φM) and pulse modulation
<b>Amplitude modulation</b>	
	internal, external AC/DC
Modulation depth	0% to 100%
AM distortion at 1 kHz, m=30%	<1%
Modulation frequency range	DC to 100 kHz
<b>Frequency modulation</b>	
	internal, external AC/DC, two-tone with two separate channels FM1 and FM2
Maximum deviation	depending on carrier frequency: 5 MHz (at f <sub>c</sub> < 130 MHz) to 40 MHz (at f <sub>c</sub> 6 GHz)
FM distortion at AF=1 kHz and 50% of max. deviation	typ. 0.1%
Modulation frequency response	
20 Hz (DC) to 100 kHz	0.5 dB
Stereo modulation	
Crosstalk attenuation	>50 dB
Unweighted S/N ratio	>76 dB
Carrier frequency offset (FM DC)	<0.1% of deviation
<b>Phase modulation</b>	
	internal, external AC/DC, two-tone with two separate channels broadband φM or narrowband φM (broadband φM only possible with φM2)
Maximum deviation	depending on carrier frequency
φM range 1: DC to 100 kHz	12.5 rad to 400 rad
φM range 2: DC to 2 MHz	0.625 rad to 20 rad
<b>Pulse modulation</b>	
	option R&S® SM-B3/-B8/-B9
Operating modes	external; internal with optional Pulse Generator R&S® SM-B4
On/off ratio	>80 dB
Rise/fall time (10%/90%)	<10 ns
<b>Internal modulation generator</b>	
	0.4/1/3/15 kHz ±3%
Level (EMF) at LF socket	1 V ±1% (R <sub>out</sub> =10 Ω, R <sub>L</sub> >200 Ω)
<b>LF generator</b>	
	option R&S® SM-B2
Sinewave, noise	0.1 Hz to 500 kHz
Triangular, squarewave	0.1 Hz to 50 kHz
Distortion (20 Hz to 100 kHz)	<0.1% (level >0.5 V)
Level (EMF) at LF socket	1 mV to 4 V (R <sub>out</sub> =10 Ω, R <sub>L</sub> >200 Ω)

<b>Multifunction generator</b>	option R&S® SM-B6
Modulation signals	sinewave, triangular, sawtooth, squarewave, noise, stereo MPX, VOR/ILS
Sinewave, noise	0.1 Hz to 1 MHz
Triangular, sawtooth, squarewave	0.1 Hz to 50 kHz
Distortion (20 Hz to 100 kHz)	<0.1% (level >0.5 V)
Level (EMF) at LF socket	1 mV to 4 V (R <sub>out</sub> =10 Ω, R <sub>L</sub> >200 Ω)
<b>Stereo multiplex signal</b>	
	with option R&S® SM-B6
Stereo operating modes	R, L, R=L, R=-L, ARI (pilot tone or MPX signal can be connected to LF socket)
Frequency range of L, R signal	0.1 Hz to 15 kHz
Preemphasis	50 μs, 75 μs
Pilot-tone frequency	19 kHz ±1 Hz
Pilot phase/resolution	0° to 360°/0.1°
<b>VOR modulation signal</b>	
	option R&S® SM-B6
Settings	30 Hz (VAR, REF)/ 9.96 kHz FM carrier, FM deviation, COM/ID tone
Phase/phase resolution	0° to 360°/0.01°
Bearing error (RF output, 108 MHz to 118 MHz)	<0.05°
<b>ILS modulation signal</b>	
	option R&S® SM-B6
Settings	90 Hz, 150 Hz tone, COM/ID tone, marker beacon
DDM setting range/resolution	0 to ±0.8/0.0001
DDM error (RF output)	
Localizer (108 MHz to 112 MHz)	<0.0004 + 1% of DDM reading
Glideslope (329 MHz to 335 MHz)	<0.0008 + 1% of DDM reading
<b>Pulse generator</b>	
	option R&S® SM-B4
Operating modes	single, delayed and double pulse
Pulse repetition period	100 ns to 85 s
Pulse width	20 ns to 1 s
Pulse delay	40 ns to 1 s
Double pulse	60 ns to 1 s
<b>Sweep</b>	
digital sweep	in discrete steps for RF, level and LF
LF sweep	option R&S® SM-B2 or R&S® SM-B6
<b>General data</b>	
Remote control	IEC625 (IEEE488)
Power supply	100 V to 240 V, 50 Hz to 400 Hz (300 VA)
Power consumption	max. 210 W (2.7 to 1.1 A)
Dimensions (W × H × D)	435 mm × 192 mm × 350 mm
Weight	20 kg for fully equipped unit

## Ordering information

<b>Signal Generator</b>	R&S® SMT02	1039.2000.02
	R&S® SMT03	1039.2000.03
	R&S® SMT06	1039.2000.06
<b>Options</b>		
Reference Oscillator OCXO	R&S® SM-B1	1036.7599.02
LF Generator	R&S® SM-B2	1036.7947.02
Pulse Modulator		
for R&S® SMT02	R&S® SM-B3	1036.6340.02
for R&S® SMT03	R&S® SM-B8	1036.6805.02
for R&S® SMT06	R&S® SM-B9	1039.5100.02
Pulse Generator (only in combination with R&S® SM-B3, -B8 or -B9)	R&S® SM-B4	1036.9310.02
Multifunction Generator	R&S® SM-B6	1036.7760.02
Rear Connectors for RF and LF	R&S® SMT-B19	1039.4003.02





Contents Overview

Chapter Overview

Type Index

R&amp;S Addresses



## Signal Generator R&amp;S®SML

R&amp;S®SML01: 9 kHz to 1.1 GHz

R&amp;S®SML02: 9 kHz to 2.2 GHz

R&amp;S®SML03: 9 kHz to 3.3 GHz

Economy at its best

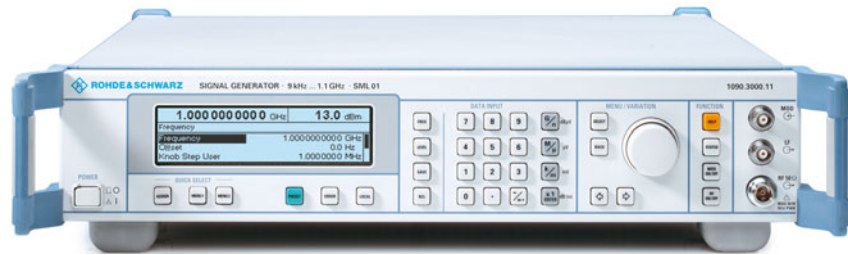

Signal Generator R&amp;S®SML01

## Brief description

R&S®SML offers all features required of a state-of-the-art general-purpose signal generator: wide frequency range, large variety of modulation functions and high reliability – at an extremely attractive price. The fields of application of R&S®SML are virtually unlimited in development, servicing or production where it is used as a flexible signal source in automatic test systems. R&S®SML benefits both from our long-standing experience in the field of signal generators and the latest technology. Its uses are as versatile as its functionalities.

## Main features

## Frequency

- ◆ 9 kHz to 1.1 GHz/2.2 GHz/3.3 GHz
- ◆ 0.1 Hz frequency resolution

## Level

- ◆ –140 dBm to +13 dBm (+19 dBm overrange)
- ◆ High level accuracy (deviation <0.5 dB)
- ◆ Level setting without overshoots
- ◆ Electronic attenuator
- ◆ Non-interrupting level setting

## Spectral purity

- ◆ SSB phase noise <–122 dBc (1 Hz), typ. <–128 dBc (1 Hz) (at carrier offset 20 kHz)

- ◆ Broadband noise <–140 dBc (1 Hz), typ. –150 dBc (1 Hz) (f = 1 GHz, carrier offset >2 MHz)

## Speed

- ◆ Setting times <10 ms for frequency and level

## Modulation

- ◆ AM/FM/φM as standard
- ◆ Simultaneous operation of AM, FM/φM and pulse modulation
- ◆ Optional pulse modulator with integrated pulse generator (R&S®SML-B3)

## Low cost of ownership

- ◆ 3-year calibration cycle
- ◆ Low purchase price
- ◆ High reliability through electronic attenuator (wear-free)
- ◆ Service-friendly (continuous selftest, access to internal test points via LCD)
- ◆ Options OCXO (R&S®SML-B1) and pulse modulator (R&S®SML-B3) retrofittable

## Size

- ◆ Compact size: 427 mm × 88 mm × 450 mm
- ◆ Low weight: <8 kg

## Applications

## The use of a signal generator in the laboratory requires

- ◆ Wide frequency range
- ◆ High spectral purity

- ◆ High and accurate output level
- ◆ Very good modulation characteristics

## These features are particularly important in servicing

- ◆ High mobility
- ◆ Flexible control
- ◆ Protection against overvoltage

## In production these factors play a vital role

- ◆ Accuracy for high yield
- ◆ Speed for high throughput
- ◆ Reliability for undisturbed operation

## EMS measurements require

- ◆ Non-interrupting level setting
- ◆ Level setting without overshoots
- ◆ Wide frequency range

## Stereo/RDS Coder R&amp;S®SML-B5 (option)

Fitted with the new option, the signal generators of the tried and tested R&S®SML and R&S®SMV families generate stereo-modulated RF signals to standard for use in production, development and service. At the core of this option is a digital signal processor (DSP) that generates stereo, RDS and ARI signals of outstanding quality, which is fully sustained owing to the excellent FM modulators in the generators.



Contents Overview

Chapter Overview

Type Index

R&amp;S Addresses





## User-friendly operation

- ◆ One-hand operation with EasyWheel
- ◆ All settings simple and self-explanatory
- ◆ High-contrast LC display
- ◆ User-assignable menu keys
- ◆ Online help including IEC/IEEE-bus commands

## Specifications in brief

You will find detailed and binding data on the enclosed CD (./DATASHEET/SML.pdf), or, for the latest updates, visit [www.rohde-schwarz.com](http://www.rohde-schwarz.com), search term: SML

Frequency	
Range	9 kHz to 1.1 GHz
R&S®SML01	9 kHz to 1.1 GHz
R&S®SML02	9 kHz to 2.2 GHz
R&S®SML03	9 kHz to 3.3 GHz
Resolution	0.1 Hz
Setting time (for an offset of $<1 \times 10^{-7}$ or $<90$ Hz for $f \leq 76$ MHz)	$<10$ ms
Spectral purity	
Spurious signals	
Harmonics <sup>1)</sup>	
R&S®SML01	$<-30$ dBc at levels $\leq +10$ dBm
R&S®SML02/R&S®SML03	
$f \leq 20$ kHz	$<-25$ dBc at levels $\leq +8$ dBm
$f > 20$ kHz	$<-30$ dBc at levels $\leq +8$ dBm
Subharmonics	
$f \leq 1.1$ GHz	none
$f > 1.1$ GHz	$<-50$ dBc
Nonharmonics	$<-70$ dBc
(carrier offset $> 10$ kHz)	
$f \leq 1.1$ GHz	$<-70$ dBc
$f > 1.1$ GHz to 2.2 GHz	$<-64$ dBc
$f > 2.2$ GHz to 3.3 GHz	$<-58$ dBc
Broadband noise <sup>4)</sup> ( $f = 1$ GHz, carrier offset $> 2$ MHz, 1 Hz bandwidth)	$<-140$ dBc, typ. $-150$ dBc
SSB noise ( $f = 1$ GHz, 20 kHz carrier offset, 1 Hz bandwidth)	$<-122$ dBc, typ. $-128$ dBc
Spurious FM, rms ( $f = 1$ GHz)	
0.3 kHz to 3 kHz	$<4$ Hz, typ. 1 Hz
0.03 kHz to 20 kHz	$<10$ Hz, typ. 3 Hz
Spurious AM, rms (0.03 kHz to 20 kHz)	$<0.02\%$
Level	
Range	$-140$ dBm to $+13$ dBm <sup>3)</sup> (overrange $+19$ dBm)
Resolution	0.1 dB
Total level deviation <sup>3)</sup> output $>-120$ dBm	
R&S®SML01	$<0.5$ dB
R&S®SML02/R&S®SML03	
100 kHz to $\leq 2$ GHz	$<0.5$ dB
$f > 2$ GHz	$<0.9$ dB
Frequency response at 0 dBm <sup>3)</sup>	
R&S®SML01	$<0.5$ dB, typ. 0.3 dB
R&S®SML02/R&S®SML03	
100 kHz to $\leq 2$ GHz	$<0.7$ dB
$f > 2$ GHz	$<1.0$ dB
VSWR R&S®SML01	$<1.5$
VSWR R&S®SML02/03	
100kHz to 1.5 GHz	1.6
$f > 1.5$ GHz	2.3
Setting time (IEC/IEEE bus), $f > 100$ kHz	$<10$ ms, typ. 5 ms
Non-interrupting level setting <sup>4)</sup>	20 dB, overrange 30 dB

<b>Overvoltage protection</b>	safeguards unit against externally applied RF power and DC voltage (50 $\Omega$ source)
Max. permissible RF power $f \leq 2.2$ GHz	50 W
Max. permissible RF power $f > 2.2$ GHz	25 W
Max. permissible DC voltage	35 V
Internal modulation generator	
Frequency range	0.1 Hz to 1 MHz
Frequency response (up to 500 kHz, level $>100$ mV)	$<0.5$ dB
THD (up to 100 kHz, level 4 V, 600 $\Omega$ )	$<0.1\%$
Open-circuit voltage $V_o$ (LF connector)	1 mV to 4 V
Frequency setting time	$<10$ ms
<b>Simultaneous modulation</b>	AM, FM/ $\phi$ M and pulse modulation
Amplitude modulation <sup>3)</sup>	
Operating modes	internal, external AC/DC, internal/external two-tone
Modulation depth	0% to 100%
AM distortion at 1 kHz, $m = 30\%$	$<1\%$
Modulation frequency range (3 dB), $f > 100$ kHz	DC/10 Hz to 50 kHz
Frequency modulation	
Operating modes	internal, external AC/DC, internal/external two-tone
Frequency deviation	
9 kHz to 76 MHz	0 Hz to 1 MHz
$>76$ MHz to 151.3125 MHz	0 Hz to 125 kHz
$>151.3125$ MHz to 302.625 MHz	0 Hz to 250 kHz
$>302.625$ MHz to 605.25 MHz	0 Hz to 500 kHz
$>605.25$ MHz to 1.2105 GHz	0 Hz to 1 MHz
$>1.2105$ GHz to 1.818 GHz	0 Hz to 2 MHz
$>1.818$ GHz to 2.655 GHz	0 Hz to 3 MHz
$>2.655$ GHz to 3.300 GHz	0 Hz to 4 MHz
FM distortion (at AF = 1 kHz and 50% of max. deviation)	$<0.2\%$ , typ. 0.1 %
Modulation frequency range ( $-3$ dB), standard/wide	DC/10 Hz to 100 kHz/500 kHz
Stereo modulation at 40 kHz useful deviation, AF = 1 kHz, RF = 87 to 108 MHz	
Crosstalk	$>50$ dB
S/N ratio unweighted, rms	$>70$ dB
S/N ratio weighted, rms	$>70$ dB
Distortion	typ. 0.1 %
Carrier frequency offset at FM DC	typ. 0.1% of set deviation
Phase modulation	
Operating modes	internal, external AC/DC, internal/external two-tone
Phase deviation <sup>1)</sup>	
9 kHz to 76 MHz	0 rad to 10 (2) rad
$>76$ MHz to 151.3125 MHz	0 rad to 1.25 (0.25) rad
$>151.3125$ MHz to 302.625 MHz	0 rad to 2.5 (0.5) rad
$>302.625$ MHz to 605.25 MHz	0 rad to 5 (1) rad
$>605.25$ MHz to 1.2105 GHz	0 rad to 10 (2) rad
$>1.2105$ GHz to 1.818 GHz	0 rad to 20 (4) rad
$>1.818$ GHz to 2.655 GHz	0 rad to 30 (6) rad
$>2.655$ GHz to 3.300 GHz	0 rad to 40 (8) rad
Modulation frequency range ( $-3$ dB), standard/wide	DC/10 Hz to 100 kHz/500 kHz



Contents Overview

Chapter Overview

Type Index

R&amp;S Addresses



## Signal Generator R&amp;S®SML

<b>Pulse modulation (with option R&amp;S®SML-B3)</b>	
Operating modes	internal, external
On/off ratio	>90 dB
Rise/fall time (10%/90%)	<20 ns, typ. 10 ns
Pulse repetition frequency	0 Hz to 2.5 MHz
Pulse delay	typ. 50 ns
<b>Pulse generator (with option R&amp;S®SML-B3)</b>	
Operating modes	automatic, externally triggered, external gate mode, single pulse, double pulse, delayed pulse (externally triggered)
Active trigger edge	positive or negative
Pulse period	100 ns to 85 s
Pulse width	20 ns to 1 s
Pulse delay	20 ns to 1 s
Double-pulse spacing	20 ns to 1 s
Trigger delay	typ. 50 ns
<b>Sweep</b>	digital in discrete steps
RF sweep, AF sweep	
Operating modes	automatic, single shot, manually or externally triggered, linear or logarithmic
Sweep range	user-selectable
Step width (lin)	user-selectable
Step width (log)	0.01% to 100%
Level sweep	
Operating modes	automatic, single-shot, manually or externally triggered, logarithmic
Sweep range	user-selectable
Step width (log)	user-selectable
Step time	10 ms to 1 s
Resolution	0.1 ms
<b>Stereo/RDS Coder (with option R&amp;S®SML-B5)</b>	
The specifications apply to RF frequencies in the range 66 MHz to 110 MHz.	
Stereo modes	
Internal with modulation generator	L, R, R = L, R = -L
External analog (via L and R inputs) or external digital (via S/P DIF input)	L, R, R = L, R = -L, R ≠ L
	internal generation of ARI/RDS signals, 5 user-selectable RDS data sets, simultaneous generation of MPX, ARI and RDS signals possible
MPX frequency deviation	0 Hz to 80 kHz
L, R signal	
AF frequency range	20 Hz to 15 kHz
AF frequency response (referenced to 500 Hz, 40 Hz to 15 kHz)	<0.2 dB
Stereo crosstalk attenuation (1 kHz)	>50 dB
Distortion (at 67.5 kHz MPX frequency deviation, AF = 1 kHz)	<0.1%, typ. 0.05%
S/N ratio <sup>1)</sup> (stereo/RDS signal)	
ITU-R weighted (quasi-peak)	>60 dB, typ. 63 dB
ITU-R unweighted (rms)	>70 dB, typ. 74 dB
A-weighted (rms)	>70 dB, typ. 76 dB
Preemphasis	off, 50 μs, 75 μs
Pilot tone	
Frequency	19 kHz ±2 Hz
Deviation	0 Hz to 10 kHz
Phase (relative to 38 kHz phase)	0° to ±5°
ARI/RDS subcarrier frequency	57 kHz ±6 Hz
ARI frequency deviation	0 Hz to 10 kHz
RDS frequency deviation	0 Hz to 10 kHz

ARI/RDS	functions (directly selectable by menu or remote control)
ARI identification	selection of traffic announcement identification (DK) or area identification (BK), OFF, DK, BK, DK + BK
ARI BK	selection of standardized area identification A to F
RDS traffic program	traffic program off/on
RDS traffic announcement	traffic announcement off/on
RDS data set	selection of RDS data set 1 to 5
Maximum data length	64 kByte, can be loaded via IEC60625 or RS-232-C interface

1) Generator without preemphasis, receiver with deemphasis.

## General data

Memory for device settings	100 storable settings
Remote control	IEC625 (IEEE488) and RS-232-C
Nominal temperature range	0°C and 55°C
Power supply	100 V to 120 V (AC), 50 Hz to 60 Hz, 200 V to 240 V (AC), 50 Hz to 60 Hz, autoranging, max. 150 VA
Dimensions (W × H × D)	427 mm × 88 mm × 450 mm
Weight	<8 kg when fully equipped

## Ordering information

<b>Signal Generator</b>	R&S®SML01	1090.3000.11
	R&S®SML02	1090.3000.12
	R&S®SML03	1090.3000.13
<b>Accessories supplied</b>	power cable, user manual	
<b>Options</b>		
Reference Oscillator OCXO	R&S®SML-B1	1090.5790.02
Pulse Modulator	R&S®SML-B3	1090.5403.02 <sup>8)</sup>
Stereo/RDS Coder	R&S®SML-B5	1147.8805.02
Rear Connectors for AF, RF	R&S®SML-B19	1090.5303.02 <sup>8)</sup>
<b>Extras</b>		
Service Kit	R&S®SML-Z2	1090.5203.02
19" Rack Adapter	R&S®ZZA-211	1096.3260.00
Transport Bag	R&S®ZZT-214	1109.5119.00
Service Manual Modules		1090.3123.24

1) With option R&S®SML-B3 only for f >20 MHz.

2) With Attenuator Mode Auto.

3) R&S®SML02, R&S®SML03: +11 dBm at f ≤5MHz, f >3GHz.

4) With Attenuator Mode Fixed.

5) With Attenuator Mode Auto, f ≥100 kHz.

6) With option R&S®SML-B3 only for f >10 MHz.

7) Values in brackets apply to wide modulation bandwidth.

8) Factory-fitted only.



Contents Overview

Chapter Overview

Type Index

R&amp;S Addresses





Contents Overview

Chapter Overview

Type Index

R&amp;S Addresses



## RF Signal Generator R&S®SM300

9 kHz to 3 GHz

Professional signal generator for  
production, laboratory and service

**New**



### Brief description

The R&S®SM300 is a favourably priced signal generator for applications in the 9 kHz to 3 GHz frequency range. The instrument features a broad scope of functions, outstanding technical characteristics and compact design.

The R&S®SM300 offers an immense range of applications — whether on the lab bench, in service or as a flexible measuring instrument in automatic production systems.

### Applications

- ◆ Generation of precise test signals for the following applications: lab, service, production and quality assurance
- ◆ Provision of digitally modulated signals in the 9 kHz to 3 GHz frequency range (e.g. with the R&S®AM300 as an external baseband signal source)
- ◆ Signal generation and modulation (AM, pulse) for EMC measurements of components (EMS)
- ◆ Functionality testing of components in production

### Main features

- ◆ High signal quality
- ◆ Internal I/Q modulator
  - High I/Q bandwidth for W-LAN measurements in accordance with IEEE802.11b and IEEE802.11g
  - Generation of WCDMA test signals for measuring ACLR, EVM and code domain power
  - Generation of GSM signals for measuring phase error
- ◆ All analog modulation modes
- ◆ Frequency sweep, level sweep
- ◆ High level accuracy
- ◆ Internal pulse generator
- ◆ Semi-automatic measurements by pressing a button to retrieve stored settings
- ◆ USB remote control

### Characteristics

In addition to standard analog modulation modes, external I/Q signals can be fed in for RF signal modulation. Digitally modulated signals can thus be generated, as required in mobile radio, for example.

The internal LF generator (20 Hz to 80 kHz) and the wide range of analog modulation modes such as AM, FM,  $\phi$ M, and pulse make the R&S®SM300 a universal signal source. In addition, the built-in square wave generator and pulse modulator can generate bursts.

An innovation in this price category is the capability to modulate the output signal by means of analog I/Q signals (as generated by the Dual-Channel Arbitrary/Function Generator R&S®AM300, for example) in order to generate almost any signal. The I/Q modulator bandwidth of 40 MHz is fully sufficient for all common wireless transmission methods such as GSM, WCDMA and WLAN.

Operation is menu-guided so that even untrained users will quickly obtain correct results. Clear structures simplify navigation within the menus. The bright TFT colour display with 320 × 240 pixel resolution allows traces to be read even at odd angles or when the incidence of light is unfavourable.



Contents Overview

Chapter Overview

Type Index

R&amp;S Addresses





Contents Overview

Chapter Overview

Type Index

R&amp;S Addresses



## RF Signal Generator R&amp;S®SM300

## Specifications in brief

You will find detailed and binding data on the enclosed CD (./DATASHEET/SM300.pdf), or, for the latest updates, visit [www.rohde-schwarz.com](http://www.rohde-schwarz.com), search term: SM300

RF frequency	
Frequency range	9 kHz to 3 GHz
Resolution	0.1 Hz
Setting time	<10 ms
Spectral purity	
Spurious	
Harmonics (level ≤0 dBm, $f_c > 1$ MHz)	<-30 dBc
Nonharmonics (>10 kHz from carrier)	<-50 dBc
Wideband noise (carrier offset >2 MHz, $f_c = 1$ GHz)	<-123 dBc (1 Hz)
Single-sideband phase noise (carrier offset 20 kHz, $f_c = 1$ GHz)	<-95 dBc (1 Hz)
Residual FM (rms, $f_c = 1$ GHz)	
0.3 Hz to 3 kHz	<10 Hz
.03 kHz to 20 kHz	<60 Hz
Residual AM (rms, $f_c = 1$ GHz)	
0.3 kHz to 3 kHz	<0.03%
RF level	
Level range	-127 dBm to +13 dBm
Setting time	<10 ms
Setting resolution	0.1 dB
Level uncertainty (level >-120 dBm, 20°C to 30°C)	<1 dB
LF generator	
Frequency range	20 Hz to 80 kHz
Frequency setting resolution	0.1 Hz
Frequency response (20 Hz to 20 kHz)	<0.2 dB
Total harmonic distortion (20 Hz to 20 kHz)	<0.1%
Modulation	
Amplitude modulation	
Operating modes	internal, external AC/DC
Modulation depth	0% to 100%
Resolution	0.1%
Setting uncertainty ( $f_{LF} = 1$ kHz, $m < 80\%$ , level ≤0 dBm)	<5% + 0.07%
AM total harmonic distortion ( $f_{LF} = 1$ kHz, $m < 80\%$ , level ≤0 dBm)	<2%
Modulation frequency range	DC/20 Hz to 20 kHz
Frequency modulation	
Operating modes	internal, external AC/DC
Frequency deviation	20 Hz to 100 kHz
Resolution	<1%
Setting uncertainty ( $f_{LF} = 1$ kHz)	<5% + residual FM
FM total harmonic distortion ( $f_{LF} = 1$ kHz, deviation = 50 kHz)	<1%
Modulation frequency range	DC/20 Hz to 80 kHz
Phase modulation	
Operating modes	internal
Phase deviation	
$f_{LF} \leq 10$ kHz	0 to 10 rad
10 kHz < $f_{LF} \leq 20$ kHz	0 to 5 rad
Resolution	<1%, min. 0.001 rad

Setting uncertainty ( $f_{LF} = 1$ kHz)	<5% + 0.02 rad
$\phi$ M total harmonic distortion ( $f_{LF} = 1$ kHz, deviation = 5 rad)	<1.5%
Modulation frequency range	300 Hz to 20 kHz
I/Q modulation	
Operating modes	external
Modulation frequency range (3 dB)	DC to 40 MHz
Carrier suppression ( $f_c = 1.8$ GHz)	typ. -40 dBc
ACLR WCDMA 3GPP FDD	Test model 1
Offset 5 MHz	typ. -54 dBc
Offset 10 MHz	typ. -55 dBc
Composite EVM (64 DPCH channels)	typ. 3.3%
Generation of GSM signals	
Phase error	typ. 1.2° rms
Pulse modulation/pulse generator	
Operating modes	external, internal
Rise/fall time (10%/90%)	<500 ns
Delay time (external)	100 $\mu$ s to 1 s
Pulse width (internal, external)	100 $\mu$ s to 1 s
Pulse period (internal)	200 $\mu$ s to 2 s
Time resolution	1 $\mu$ s
Sweep	
RF sweep, LF sweep	
Operating modes	continuous sweep, single sweep, single step
Sweep range RF (LF 20 Hz to 80 kHz)	9 kHz to 3 GHz,
Step width (log)	0.01% to 100%
Step width (lin) RF (LF 0.1 Hz to 80 kHz)	0.1 Hz to 1 GHz
Level sweep	
Operating modes	continuous sweep, single sweep, single step
Sweep range	-127 dBm to 13 dBm
Step width	1 dB to 20 dB
Step time	10 ms to 1 s
Interfaces	
USB host	Connector A plug, protocol version 1.1
Command set	Device-specific, remote control via supplied Windows driver (Windows XP, 2000)
USB device	Connector B plug, protocol version 1.1
Power supply	
Input voltage range	100 V to 240 V (AC), 50 Hz to 60 Hz, autoranging
Power consumption	<35 VA
General data	
Display	5.4" active colour TFT display
Resolution	320 × 240 pixel
Memory locations	10 device setups
Operating temperature range	+5°C to +45°C
Dimensions (W × H × D)	219 mm × 147 mm × 350 mm
Weight approx.	7 kg

## Ordering information

RF Signal Generator	R&S®SM300	1147.1498.03
Recommended extra		
Rack Adapter	R&S®ZZA-300	1147.1281.00
Carrying Case		on request



Contents Overview

Chapter Overview

Type Index

R&amp;S Addresses



## Microwave Signal Generator R&amp;S®SMP

## R&amp;S®SMP02/22:

0.01/2 GHz to 20 GHz

R&amp;S®SMP03: 0.01/2 GHz to 27 GHz

R&amp;S®SMP04: 0.01/2 GHz to 40 GHz

Excellent signal characteristics and  
high output power up to 40 GHz

*Microwave Signal Generator R&S®SMP04*

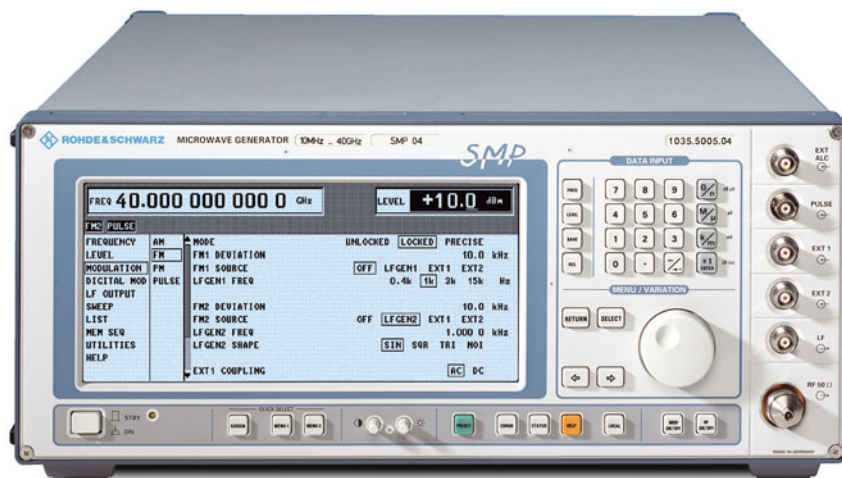

## Brief description

The Microwave Signal Generator R&S®SMP is a reliable, high-precision signal source featuring high output power, high spectral purity and excellent pulse modulation. It is able to supply signals for any measurements on radar and communications receivers. A wide range of extensions ensures universal use in R&D, production, EMC and environmental measurements as well as in material testing.

The R&S®SMP is ideal for the following applications:

- ◆ Substitution of local oscillators
- ◆ Measurements on nonlinear components such as frequency multipliers or high-level mixers
- ◆ Driving of travelling wave tubes (TWTs) and other power stages, e.g. for EMC applications
- ◆ Interconnection of several signal generators for intermodulation measurements
- ◆ Tracking generator for spectrum and network analyzers

## Overview of options

Designation, functions	Option
<b>Reference Oscillator OCXO:</b> aging $<1 \times 10^{-7}$ /year	R&S®SMP-B1
<b>LF Generator:</b> supplies sinewave, noise 0.1 Hz to 500 kHz, triangular, squarewave 0.1 Hz to 50 kHz signals	R&S®SM-B2
<b>FM/φM Modulator:</b> FM DC to 1 MHz, φM DC to 100 kHz, precision FM DC	R&S®SM-B5
<b>Frequency Extension 0.01 GHz to 2 GHz<sup>1)</sup>:</b> extends the lower frequency limit to 10 MHz	R&S®SMP-B11
<b>Pulse Modulator 2 GHz to 20 GHz<sup>1)</sup>:</b> on/off ratio >80 dB, rise/fall time <10 ns; for R&S®SMP02 and R&S®SMP22 only	R&S®SMP-B12, model .02
<b>Pulse Modulator 2 GHz to 27 GHz<sup>1)</sup>:</b> on/off ratio >80 dB, rise/fall time <10 ns; for R&S®SMP03 only	R&S®SMP-B12, model .03
<b>Pulse Modulator 2 GHz to 40 GHz<sup>1)</sup>:</b> on/off ratio >80 dB, rise/fall time <10 ns; for R&S®SMP04 only	R&S®SMP-B12, model .04
<b>Pulse Modulator 0.01 GHz to 2 GHz<sup>1)</sup>:</b> on/off ratio >80 dB, rise/fall time <10 ns	R&S®SMP-B13
<b>Pulse Generator:</b> provides single, delayed and double pulses	R&S®SMP-B14
<b>RF Attenuator 27 GHz<sup>1)</sup>:</b> allows level setting down to -130 dBm; for R&S®SMP02, R&S®SMP22 and R&S®SMP03 only	R&S®SMP-B15
<b>RF Attenuator 40 GHz<sup>1)</sup>:</b> allows level setting down to -130 dBm; for R&S®SMP04 only	R&S®SMP-B17
<b>Auxiliary Interface:</b> V/GHz output, Z output for scalar network analyzers	R&S®SMP-B18
<b>Rear Connectors for RF and AF<sup>1)</sup>:</b> to replace front-panel connectors; for R&S®SMP02, R&S®SMP22 and R&S®SMP03 only	R&S®SMP-B19
<b>Rear Connectors for RF and AF<sup>1)</sup>:</b> to replace front-panel connectors; for R&S®SMP04 only	R&S®SMP-B20

1) Factory-fitted option.



## Main features

- ◆ Instrument family with four models
  - R&S®SMP02 (10 MHz to 20 GHz)
  - R&S®SMP22 (10 MHz to 20 GHz)
  - R&S®SMP03 (10 MHz to 27 GHz)
  - R&S®SMP04 (10 MHz to 40 GHz)
- ◆ High output level
  - R&S®SMP02 >+11.5 dBm
  - R&S®SMP22 >+20 dBm (typ. +29 dBm at 2 GHz)
  - R&S®SMP03 >+13 dBm
  - R&S®SMP04 >+10 dBm
- ◆ Optional pulse modulator and pulse generator
- ◆ Digital RF, AF and level sweep
- ◆ Storage of 50 complete instrument setups
- ◆ Optional phase modulator

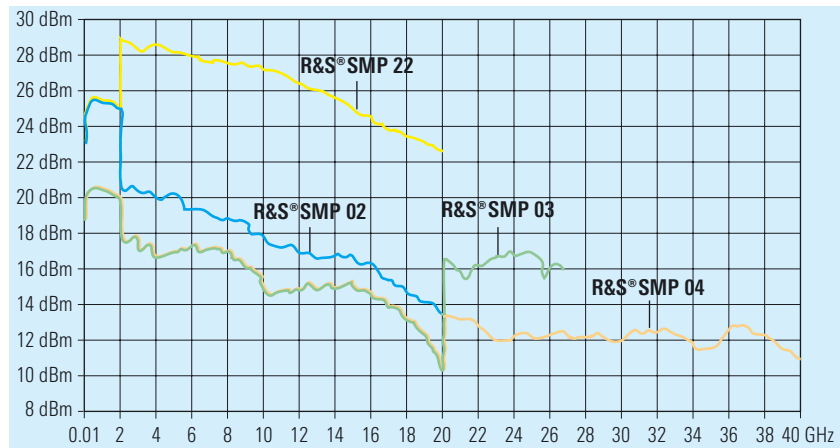

Typical maximum level versus frequency

- ◆ ASK/FSK modulation, phase offset settings
- ◆ Extremely low SSB phase noise at 10 GHz (<-105 dBc (1 Hz) at 10 kHz from carrier)
- ◆ Very short frequency setting time <11 ms + 5 ms/GHz
- ◆ Extremely high level accuracy <±0.9 dB at 0 dBm in frequency range 10 MHz to 40 GHz

## Specifications in brief

You will find detailed and binding data on the enclosed CD (./DATASHEET/R&S®SMP.pdf), or, for the latest updates, visit [www.rohde-schwarz.com](http://www.rohde-schwarz.com), search term: R&S®SMP

### Frequency

Range (standard)	
R&S®SMP02/R&S®SMP22	2 GHz to 20 GHz
R&S®SMP03	2 GHz to 27 GHz
R&S®SMP04	2 GHz to 40 GHz
Range (with option R&S®SMP-B11)	
R&S®SMP02/R&S®SMP22	10 MHz to 20 GHz
R&S®SMP03	10 MHz to 27 GHz
R&S®SMP04	10 MHz to 40 GHz
Resolution	0.1 Hz
Setting time (to within $<1 \times 10^{-9}$ ) after IEC/IEEE-bus delimiter	<(11 ms + 5 ms/GHz) <sup>1</sup>
Phase offset	adjustable in 1° steps

### Spectral purity

Spurious signals	R&S®SMP02	R&S®SMP22	R&S®SMP03	R&S®SMP04
Harmonics				
f < 1.8 GHz	<-30 dBc	<-25 dBc	<-30 dBc	<-30 dBc
f ≥ 1.8 GHz	<-40 dBc	<-25 dBc	<-40 dBc	<-40 dBc
Harmonics (with options R&S®SMP-B12/-B13, pulse modulation on)				
f < 1.8 GHz	<-25 dBc	<-25 dBc	<-25 dBc	<-25 dBc
f ≥ 1.8 GHz	<-25 dBc	<-25 dBc	<-25 dBc	<-25 dBc
Subharmonics				
f ≤ 20 GHz	-	-	-	-
f > 20 GHz	-	-	<-40 dBc	<-30 dBc
Nonharmonics at >10 kHz from carrier				
2 to 20 GHz	<-60 dBc	<-60 dBc	<-60 dBc	<-60 dBc

### SSB phase noise, 1 Hz bandwidth, FM off

	Offset from carrier			
Frequency range	100 Hz	1 kHz	10 kHz	100 kHz
2 GHz to 10 GHz	<-64 dBc	<-93 dBc	<-105 dBc	<-105 dBc

### Level

Maximum level R&S®SMP02/22 (without options R&S®SMP-B12/-B13)				
Frequency range	R&S®SMP02		R&S®SMP22	
	Standard	With option R&S®SMP-B15	Standard	With option R&S®SMP-B15
10 MHz to <2 GHz	>+17 dBm			
2 GHz to 20 GHz	>+11.5 dBm	>+10 dBm	>+20 dBm	>+18.5 dBm
Maximum level R&S®SMP02/22 (with options R&S®SMP-B12/-B13)				
Frequency range	R&S®SMP02		R&S®SMP22	
	Pulse mod. off	Pulse mod. on	Pulse mod. off	Pulse mod. on
10 MHz to <2 GHz	>+13 dBm			
2 GHz to 20 GHz	>+11.5 dBm	>+13 dBm	>+20 dBm	>+13 dBm
Maximum level R&S®SMP03/04 (without options R&S®SMP-B12/-B13)				
Frequency range	R&S®SMP03		R&S®SMP04	
	Standard	With option R&S®SMP-B15	Standard	With option R&S®SMP-B17
10 MHz to <2 GHz	>+12 dBm			
2 GHz to <18 GHz	>+10 dBm	>+8.5 dBm	>+10 dBm	>+8.5 dBm
18 GHz to 20 GHz	>+6 dBm	>+4.5 dBm	>+6 dBm	>+4.5 dBm
>20 to 27/33 GHz	>+13 dBm	>+11 dBm	>+12 dBm	>+10 dBm
>33 GHz to 40 GHz	-	-	>+10 dBm	>+8 dBm
Maximum level R&S®SMP03/SMP04 (with options R&S®SMP-B12/-B13)				
Frequency range	R&S®SMP03		R&S®SMP04	
	Pulse mod. off	Pulse mod. on	Pulse mod. off	Pulse mod. on
10 MHz to <2 GHz	>+10 dBm			
2 to 20/27/40 GHz	same as max. level without options R&S®SMP-B12/-B13			
Minimum level of all models				
Without option R&S®SMP-B15/-B17		-20 dBm		
With option R&S®SMP-B15/-B17		-130 dBm		



Contents Overview

Chapter Overview

Type Index

R&amp;S Addresses



## Microwave Signal Generator R&amp;S®SMP

**Total accuracy (frequency response and temperature effect included)**

Frequency range	Level	Accuracy
2 GHz to 20 GHz	>+10 dBm	<±1.3 dB
	>-10 dBm	<±0.7 dB
	>-60 dBm	<±1.0 dB
	≤-60 dBm	<±1.5 dB

Setting time (after IEC/IEEE-bus delimiter)	<10 ms
With option R&S®SMP-B15/-B17, with switching in attenuator set	<25 ms

**Simultaneous modulation** any combination of AM (scan modulation), FM ( $\phi$ M) and pulse modulation

**Linear amplitude modulation**

Operating modes	internal, external AC/DC
Modulation depth	0% to 90%
Modulation frequency range for frequency response <1 dB, m = 60%	DC to 100 kHz
f <2 GHz	DC to 10 kHz
f ≥2 GHz	DC to 50 kHz

**Logarithmic amplitude modulation (scan modulation)**

Operating modes	internal, external
Dynamic range	>30 dB
Sensitivity	0.1 dB/V to 10 dB/V
Resolution	0.01 dB/V
Rise/fall time (10%/90%)	<10 $\mu$ s

**Frequency modulation**

Operating modes	internal, external AC/DC, locked/ unlocked, two-tone with two separate channels FM1 and FM2
-----------------	---

**Standard FM (without option R&S®SM-B5)**

Maximum deviation f ≤20 GHz	10 MHz
f >20 GHz	20 MHz
Setting accuracy at AF = 100 kHz and 500 kHz deviation	<10% of reading
Modulation frequency range Locked mode	10 kHz to 5 MHz
Unlocked mode	DC to 5 MHz

**FM (with option R&S®SM-B5)**

Maximum deviation f ≤20 GHz	1 MHz
f >20 GHz	2 MHz
Setting accuracy at AF = 1 kHz and deviation >1 kHz	<2% of reading
Modulation frequency range	DC to 1 MHz

**Phase modulation with option R&S®SM-B5**

Operating modes internal, external AC/DC, two-tone with two separate channels  $\phi$ M1 and  $\phi$ M2

Maximum deviation f ≤20 GHz	10 rad
f >20 GHz	20 rad
Setting accuracy at AF = 1 kHz f ≤20 GHz	<(3% of reading + 0.01 rad)
f >20 GHz	<(3% of reading + 0.02 rad)
Modulation frequency range	DC to 100 kHz

**ASK modulation**

Operating mode	external
Maximum modulation depth	90%
Data rate	0 Hz to 200 kHz
Rise/fall time (10%/90%)	<10 $\mu$ s

**FSK modulation**

Operating mode	external
Maximum shift	10 MHz
Standard FM, f ≤20 GHz	20 MHz
Standard FM, f >20 GHz	1 MHz
With option R&S®SM-B5, f ≤20 GHz	1 MHz
With option R&S®SM-B5, f >20 GHz	2 MHz
Data rate	20 kHz to 2 MHz
Standard FM, locked mode	0 Hz to 2 MHz
Standard FM, unlocked mode	0 Hz to 2 MHz
With option R&S®SM-B5	0 Hz to 2 MHz

**Pulse modulation**

Operating modes external, internal with option R&S®SMP-B14

**Standard (without options R&S®SMP-B12/-B13)**

Frequency range	≥2 GHz
On/off ratio	>50 dB (level >0 dBm)
Rise/fall time (10%/90%)	<500 ns

**With options R&S®SMP-B12/-B13**

Frequency range	10 MHz to <2 GHz
With option R&S®SMP-B13	≥2 GHz
With option R&S®SMP-B12	≥2 GHz
On/off ratio	>80 dB
Rise/fall time (10%/90%)	<10 ns

**Internal modulation generator**

Frequency	0.4/1/3/15 kHz ± 3%
-----------	---------------------

**LF generator option R&S®SM-B2**

Waveforms sinewave, triangular, squarewave, noise

Frequency range	0.1 Hz to 500 kHz
Sinewave, noise	0.1 Hz to 500 kHz
Triangular, squarewave	0.1 Hz to 50 kHz

Frequency response (sinewave)	<0.3 dB
Up to 100 kHz	<0.5 dB
Up to 500 kHz	<0.5 dB

Distortion (20 Hz to 100 kHz)	<0.1% (for level >0.5 V)
-------------------------------	--------------------------

**Pulse generator option R&S®SMP-B14**

Operating modes	single pulse, delayed pulse, double pulse
Pulse repetition period	100 ns to 85 s
Pulse width	40 ns to 1 s
Pulse delay	40 ns to 1 s
Double pulse	60 ns to 1 s
Trigger delay	<50 ns

**RF control output**

Frequency range	2 GHz to 20 GHz
Level	approx. 0 dBm



Contents Overview

Chapter Overview

Type Index

R&amp;S Addresses





Contents Overview

Chapter Overview

Type Index

R&amp;S Addresses



## Microwave Signal Generator R&amp;S®SMP

## Sweep

	digital sweep in discrete steps
RF sweep, AF sweep Operating modes	AF sweep with option R&S®SM-B2 automatic, single-shot, manual or externally triggered, linear or logarithmic
Sweep range	
Linear step width	user-selectable
Logarithmic step width	0.01% to 50%
Level sweep Operating modes	automatic, single-shot, manual or externally triggered, logarithmic
Sweep range	0.1 dB to 20 dB
Step width	0.1 dB to 20 dB
Step time	10 ms to 1 s
Markers	3, user-selectable

## LIST mode

Frequency and level values can be stored and read out fast; permissible level variation range: 20 dB	
Operating modes	automatic, single-shot, manual or externally triggered
Max. length of list	2003 pairs of frequency and level values

## Memory for instrument settings

Storable settings	50
Memory sequence modes Operating modes	automatic, single-shot, manual or externally triggered
Step time	50 ms to 60 s

## Auxiliary interface with option R&amp;S®SMP-B18

V/GHz output	output voltage proportional to frequency, 0.5 V/GHz or 1 V/GHz selectable
Z output	user-selectable level range -10 V to +10 V

## General data

Remote control	IEC 625 (IEEE 488)
Power supply	90 V to 132 V (AC), 47 Hz to 440 Hz 180 V to 265 V (AC), 47 Hz to 440 Hz autoranging, max. 400 VA
Operating temperature range	0 °C to 55 °C
Dimensions (W × H × D)	435 mm × 192 mm × 570 mm
Weight	27 kg, when fully equipped

## Ordering information

Order designation	Type	Order No.
Microwave Signal Generator	R&S®SMP02	1035.5005.02
Microwave Signal Generator	R&S®SMP22	1035.5005.22
Microwave Signal Generator	R&S®SMP03	1035.5005.03
Microwave Signal Generator	R&S®SMP04	1035.5005.04
<b>Accessories supplied</b>		
For R&S®SMP02/22/03	power cable, operating manual	
For R&S®SMP04	female adapter 3.5 mm	
	female adapter 2.9 mm	
<b>Options</b>		
OCXO Reference Oscillator	R&S®SMP-B1	1036.5109.02
Frequency Extension 0.01 GHz to 2 GHz <sup>1)</sup>	R&S®SMP-B11	1036.6240.02
Pulse Modulator 2 GHz to 20 GHz (R&S®SMP02, R&S®SMP22) <sup>1)</sup>	R&S®SMP-B12	1036.5750.02
2 GHz to 27 GHz (R&S®SMP03) <sup>1)</sup>	R&S®SMP-B12	1036.5750.03
2 GHz to 40 GHz (R&S®SMP04) <sup>1)</sup>	R&S®SMP-B12	1036.5750.04
0.01 GHz to 2 GHz <sup>1)</sup>	R&S®SMP-B13	1036.7147.02
Pulse Generator	R&S®SMP-B14	1036.7347.02
RF Attenuator 27 GHz (R&S®SMP02, R&S®SMP22, R&S®SMP03) <sup>1)</sup>	R&S®SMP-B15	1036.5250.02
40 GHz (R&S®SMP04) <sup>1)</sup>	R&S®SMP-B17	1036.5550.02
Auxiliary Interface	R&S®SMP-B18	1036.8920.02
Rear Connectors for RF, AF R&S®SMP02, R&S®SMP22, R&S®SMP03 <sup>1)</sup> R&S®SMP04 <sup>1)</sup>	R&S®SMP-B19 R&S®SMP-B20	1039.4303.02 1039.4503.02
LF Generator	R&S®SM-B2	1036.7947.02
FM/φM Modulator	R&S®SM-B5	1036.8489.02
19" Rack Adapter	R&S®ZZA-94	0396.4905.00
<b>Extras</b>		
Service Kit	R&S®SM-Z3	1085.2500.02
Trolley	R&S®ZZK-1	1014.0510.00
Transit Case	R&S®ZZK-945	1013.9372.00
Adapter (R&S®SMP02, R&S®SMP22, R&S®SMP03)		
3.5 mm, female		1021.0512.00
3.5 mm, male		1021.0529.00
N, female		1021.0535.00
N, male		1021.0541.00
Adapter (R&S®SMP04)		
2.9 mm, female		1036.4790.00
2.9 mm, male		1036.4802.00
N, female		1036.4777.00
N, male		1036.4783.00



Contents Overview

Chapter Overview

Type Index

R&amp;S Addresses





Contents Overview

Chapter Overview

Type Index

R&amp;S Addresses



## Microwave Signal Generator R&S®SMR

### R&S®SMR 20/27/30/40:

10 MHz to 20/27/30/40 GHz

High-performance, cost-effective  
and reliable up to 40 GHz



Microwave Signal Generator R&S®SMR40

### Brief description

The R&S®SMR family comprises four basic models designed as CW generators with pulse modulation capability. Offering an excellent price/performance ratio, each of the four basic models is ideal for the user wishing to enter the field of microwave testing at an affordable price. Should measurements become more demanding – no problem with R&S®SMR: all basic models can be upgraded fast and easily by means of options to give a signal generator with AM/FM modulation capability or a synthesized sweep generator featuring fast, fully synthesized analog ramp sweep.

### Main features

#### Wide frequency range

- ◆ R&S®SMR20: 1 GHz to 20 GHz
- ◆ R&S®SMR27: 1 GHz to 27 GHz
- ◆ R&S®SMR30: 1 GHz to 30 GHz
- ◆ R&S®SMR40: 1 GHz to 40 GHz
- ◆ Optional extension of lower frequency limit to 10 MHz (R&S®SMR-B11)
- ◆ Frequency resolution 1 kHz, optional 0.1 Hz (R&S®SMR-B3)

#### High, levelled output power

- ◆ R&S®SMR20 >+10 dBm (at 20 GHz)
- ◆ R&S®SMR27 >+11 dBm (at 27 GHz)
- ◆ R&S®SMR30/40 >+9 dBm (at 30/40 GHz)

#### High precision output level

- ◆ High precision, frequency-response-compensated level control
- ◆ The setting range can be extended to –130 dBm with the optional RF attenuator (option R&S®SMR-B15/B17)

#### Sweep capabilities

- ◆ Digital RF and level sweep (standard version)
- ◆ Analog ramp sweep (RF sweep, option R&S®SMR-B4)
- ◆ Max. sweep rate for ramp sweeps min. 600 MHz/ms (frequency >2 GHz)
- ◆ Digital sweep of LF generator (with option R&S®SMR-B5)
- ◆ 10 freely selectable frequency markers for RF sweep
- ◆ Operating modes: automatic, single-shot, manual, externally triggered

#### Maximum ease of operation

- ◆ High-contrast LC display
- ◆ Online help including IEC/IEEE bus commands
- ◆ All settings simple and self-explanatory
- ◆ User-assignable keys
- ◆ One-hand operation with EasyWheel

#### Memory

- ◆ Space for 50 complete instrument setups
- ◆ Convenient memory sequence modes

#### Optional pulse generator

##### R&S®SMR-B14

- ◆ Operating modes: single pulse, double pulse, externally triggered, gate mode
- ◆ Pulse repetition 100 ns to 85 s
- ◆ Pulse width 20 ns to 1 s

#### Optional IF input (R&S®SMR-B23/ R&S®SMR-B24/R&S®SMR-B25)

- ◆ Built-in upconverter for digitally modulated IF signals from DC to 700 MHz or from 40 MHz to 6 GHz (R&S®SMR-B25)
- ◆ Ideal for use with Vector Signal Generator R&S®SMIQ and I/Q Modulation Generator R&S®AMIQ

### Advantages at a glance

- ◆ CW generator with pulse modulation and digital frequency sweep, easily upgradeable to AM-FM signal generator and synthesized sweeper with analog ramp sweep thanks to flexible options concept
- ◆ Excellent spectral purity, high-precision output level and stable output frequency
- ◆ Simultaneous modulation modes for generation of complex modulation signals for modern communication and location systems
- ◆ Compact, lightweight, user-friendly: ideal in the lab and for field applications
- ◆ 3-year calibration cycle
- ◆ Excellent price/performance ratio



Contents Overview

Chapter Overview

Type Index

R&amp;S Addresses



## Microwave Signal Generator R&S®SMR

### Specifications in brief

You will find detailed and binding data on the enclosed CD (./DATASHEET/SMR.pdf), or, for the latest updates, visit [www.rohde-schwarz.com](http://www.rohde-schwarz.com), search term: **SMR**

Frequency		
Range	w/o option SMR-B11	with option SMR-B11
R&S®SMR20	1 GHz to 20 GHz	10 MHz to 20 GHz
R&S®SMR27	1 GHz to 27 GHz	10 MHz to 27 GHz
R&S®SMR30	1 GHz to 30 GHz	10 MHz to 30 GHz
R&S®SMR40	1GHz to 40 GHz	10 MHz to 40 GHz
Resolution	without option R&S®SMR-B3	with option R&S®SMR-B3
	1 kHz	0.1 Hz
Setting time (to within $<1 \cdot 10^{-6}$ )	$<10$ ms + 1 ms/GHz	

Spectral purity	
Spurious signals	
Harmonics	
f ≤ 20 GHz	< -55 dBc
f > 20 GHz	< -40 dBc
Subharmonics	
f ≤ 20 GHz	< -65 dBc
f > 20 GHz	< -30 dBc
Nonharmonics (>50 kHz from carrier)	
f < 20 GHz	< -60 dBc
f > 20 GHz	< -54 dBc
SSB phase noise (f = 10 GHz, 10 kHz from carrier, 1 Hz bandwidth, CW, FM OFF)	< -83 dBc

Level				
Maximum level without option R&S®SMR-B23/-B24/-B25				
Frequency range	R&S®SMR20		R&S®SMR27/SMR30/SMR40	
	w/o R&S®SMR-B15	with R&S®SMR-B15	w/o R&S®SMR-B15/-B17	with R&S®SMR-B15/-B17
0.01 to <1 GHz	>+13 dBm		>+13 dBm	
1 GHz to <18 GHz	>+11 dBm	>+10 dBm	>+8 dBm	>+7 dBm
18 GHz to 20 GHz	>+10 dBm	>+8 dBm	>+7 dBm	>+5 dBm
>20 GHz to 27 GHz	--	--	>+11 dBm	>+9 dBm
>27 GHz to 30 GHz	--	--	>+9 dBm	>+7 dBm
>30 GHz to 40 GHz	--	--	>+9 dBm	>+7 dBm

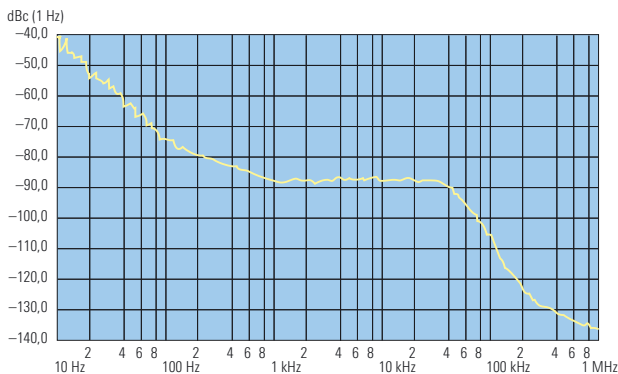

SSB phase noise at 10 GHz

Frequency range	R&S®SMR20		R&S®SMR27/SMR30/SMR40	
	w/o R&S®SMR-B15	with R&S®SMR-B15	w/o R&S®SMR-B15/-B17	with R&S®SMR-B15/-B17
0.01 GHz to <1 GHz	>+13 dBm		>+12 dBm	
1 GHz to <18 GHz	>+10 dBm	>+9 dBm	>+7 dBm	>+6 dBm
18 GHz to 20 GHz	>+8 dBm	>+6 dBm	>+5 dBm	>+3 dBm
>20 GHz to 27 GHz	--	--	>+8 dBm	>+6 dBm
>20 GHz to 30 GHz	--	--	>+6 dBm	>+4 dBm
>30 GHz to 40 GHz	--	--	>+6 dBm	>+4 dBm

Linear amplitude modulation (option R&S®SMR-B5)	
Operating modes	internal, external AC/DC
Modulation depth	0% to 100%
Modulation frequency range	DC to 100 kHz
Logarithmic amplitude modulation (option R&S®SMR-B5 (SCAN AM))	
Operating modes	internal, external
Dynamic range	-30 dB, overrange >30 dB
Sensitivity	-0.1 dB/V to -10 dB/V
Frequency modulation (option R&S®SMR-B5)	
Operating modes	internal, external AC/DC
Maximum deviation	
≤ 15.625 MHz	39.0625 kHz
> 15.625 MHz to 31.25 MHz	78.125 kHz
> 31.25 MHz to 62.5 MHz	156.25 kHz
> 62.5 MHz to 125 MHz	312.5 kHz
> 125 MHz to 250 MHz	625 kHz
> 250 MHz to 500 MHz	1.25 MHz
> 500 MHz to < 1 GHz	2.5 MHz
1 GHz to 2 GHz	5 MHz
> 2 GHz to 10 GHz	10 MHz
> 10 GHz to 20 GHz	20 MHz
f > 20 GHz	40 MHz
Modulation frequency range	DC to 5 MHz
ASK modulation (option R&S®SMR-B5)	
Operating modes	internal, external
Maximum modulation depth	90%
Data rate	0 Hz to 200 kHz

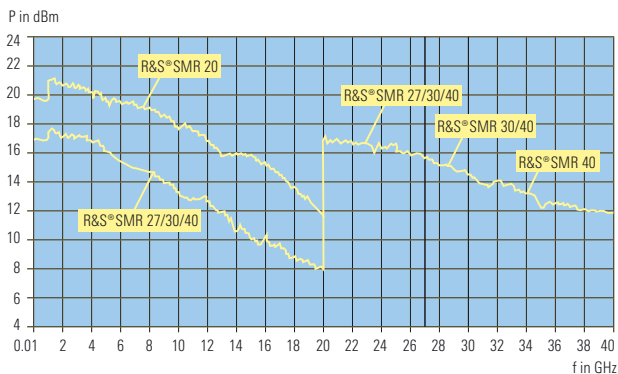

Typical maximum output level over frequency (with option SMR-B15/-B17)





Contents Overview

Chapter Overview

Type Index

R&amp;S Addresses



## Microwave Signal Generator R&amp;S®SMR

## FSK modulation (option R&amp;S®SMR-B5)

Operating modes	internal, external		
Maximum deviation	$\leq 15.625$ MHz      39.0625 kHz $> 15.625$ MHz to 31.25 MHz      78.125 kHz ranges increased by a factor of 2      increased by a factor of 2 $> 10$ GHz to 20 GHz      20 MHz $f > 20$ GHz      40 MHz		
Data rate	0 Hz to 2 MHz		
<b>Pulse modulation</b>			
Operating modes	external, internal with option SMR-B14		
On/off ratio	$> 80$ dB		
Raise-/fall time (10%/90%), $> 450$ MHz	$< 12$ ns		
Minimum pulse width, ALC OFF	20 ns		
Max/min pulse/pause, ALC ON	free		
Maximum pulse repeat frequency $> 450$ MHz	10 MHz		

## IF input (option R&amp;S®SMR-B23/-B24/-B25)

	R&S®SMR-B23	R&S®SMR-B24	R&S®SMR-B25
IF input	DC to 700 MHz	DC to 700 MHz	40 MHz to 6 GHz
RF output	1 GHz to 20 GHz	2 GHz to 27/30/40 GHz	1 GHz to 20 GHz
Conversion loss (IF input/RF output)			
with option R&S®SMR-B15/-B17 <sup>1)</sup>	6 dB to 15 dB	6 dB to 20 dB	6 dB to 15 dB
w/o option R&S®SMR-B15/-B17	6 dB to 13 dB	6 dB to 16 dB	6 dB to 13 dB

<sup>1)</sup> Option R&S®SMR-B15/-B17 in zero position. The conversion loss can be increased with option R&S®SMR-B15/-B17 by 10 dB to 110 dB in 10-dB steps. With option R&S®SMR-B19/-B20 conversion loss increases up to 0.1 dB/GHz.

## LF generator (option R&amp;S®SMR-B5)

Frequency range	0.1 Hz to 10 MHz
Waveforms	sinewave, squarewave

## Pulse generator (option R&amp;S®SMR-B14)

Operating modes	single or double pulse (automatic or externally triggered), delayed pulse (externally triggered), gate mode (external)
Pulse periode	100 ns to 85 s
Pulse width	20 ns to 1 s
Pulse delay	20 ns to 1 s
Double pulse distance	60 ns to 1 s

## Digital sweep, sweep in discrete steps

RF sweep, AF sweep		
Operating modes	automatic, single-shot, manual or externally triggered, linear or logarithmic	
Sweep range	freely selectable	
Step width (lin)	freely selectable	
Step width (log)	0.01% to 100%	
Level sweep		
Operating modes	automatic, single-shot, manual or externally triggered, logarithmic	
Sweep range	0 dB to 20 dB	
Step time	1 ms to 1 s	
Markers	10, free selectable	

## Ramp sweep (option R&amp;S®SMR-B4)

RF sweep, AF sweep		
Operating modes	automatic, single-shot, manual or externally triggered, start/stop, center frequency, center span, marker	
Sweep range	free selectable	
Sweep time	10 ms to 100 s ( $\leq 30$ ms switchover time at 1/2/10 and 20 GHz)	

Maximum sweep speed		
$\leq 15.625$ MHz	2.34375 MHz/ms	
$> 15.625$ MHz to 31.25 MHz	4.6875 MHz/ms	
ranges increased by a factor of 2	increased by a factor of 2	
$> 10$ GHz to 20 GHz	1200 MHz/ms	
$f > 20$ GHz	2400 MHz/ms	
<b>List mode</b>	Frequency and level values can be stored in a list and will be set very fast	
Permissible level variation	20 dB	
Operating modes	automatic, single-shot, manual or externally triggered	
Step time	1 ms to 1 s	

## General data

Remote control	IEC625 (IEEE 488)
Power supply	100 V to 120 V (AC), 50 Hz to 400 Hz, 200 V to 240 V (AC), 50 Hz to 60 Hz, autosetting to AC voltage, max. 200 VA
Dimensions (W x H x D)	426.7 mm x 87.6 mm x 450 mm
Weight	$< 12$ kg when fully equipped

## Ordering information

<b>Signal generator</b>	R&S®SMR 20	1104.0002.20
	R&S®SMR 27	1104.0002.27
	R&S®SMR 30	1104.0002.30
	R&S®SMR 40	1104.0002.40
<b>Accessories supplied</b>	Power cable, operating manual, adapter 3.5 mm female (R&S®SMR 20), adapter 2.9 mm female (R&S®SMR 27/30/40)	
<b>Options</b>		
Reference Oscillator OCXO	R&S®SMR-B1	1104.5485.02
Frequency Resolution 0.1 Hz	R&S®SMR-B3	1104.5585.02
Ramp Sweep	R&S®SMR-B4	1104.5685.02
AM/FM/Scan Modulator	R&S®SMR-B5	1104.3501.02
Frequency Extension 0.01 GHz to 1 GHz <sup>1)</sup>	R&S®SMR-B11	1104.4250.02
Pulse Generator	R&S®SMR-B14	1104.3982.02
RF Attenuator for R&S®SMR 20/R&S®SMR 27 <sup>1)</sup>	R&S®SMR-B15	1104.4989.02
RF Attenuator for R&S®SMR 30/R&S®SMR 40 <sup>1)</sup>	R&S®SMR-B17	1104.5233.02
Rear Connectors for RF, AF (R&S®SMR 20/R&S®SMR 27) <sup>1)</sup>	R&S®SMR-B19	1104.6281.02
Rear Connectors for RF, AF (R&S®SMR 30/R&S®SMR 40) <sup>1)</sup>	R&S®SMR-B20	1104.6381.02
IF Input 20 GHz for R&S®SMR 20 <sup>1)</sup>	R&S®SMR-B23	1104.5804.02
IF Input 40 GHz for R&S®SMR 27/R&S®SMR 30/R&S®SMR 40 <sup>1)</sup>	R&S®SMR-B24	1104.6100.02
IF Input 0.04 GHz to 6 GHz for R&S®SMR 20 <sup>1)</sup>	R&S®SMR-B25	1135.1998.02
Low MW Leakage (not with -B23/24/25) <sup>1)</sup>	R&S®SMR-B31	1164.7910.02
<b>Extras</b>		
Service Kit	R&S®SMR-Z1	1103.9506.02
Aux-port to BNC Interface	R&S®SMR-Z3	1134.9772.02
19" Rack Adapter	R&S®ZZA-211	1096.3260.00
<b>Adapter (R&amp;S®SMR 20)</b>		
3.5 mm female		1021.0512.00
3.5 mm male		1021.0529.00
N female		1021.0535.00
N male		1021.0541.00
<b>Adapter (R&amp;S®SMR 27/30/40)</b>		
2.9 mm female		1036.4790.00
2.9 mm male		1036.4802.00
N female		1036.4777.00
N male		1036.4783.00

<sup>1)</sup> Option factory-fitted only.



Contents Overview

Chapter Overview

Type Index

R&amp;S Addresses



## Microwave Signal Generators R&amp;S®SMR50/60

R&amp;S®SMR50: 10 MHz to 50 GHz

R&amp;S®SMR60: 10 MHz to 60 GHz

High-performance, cost-effective  
and reliable up to 60 GHz

*Microwave Signal Generator R&S®SMR60*



## Brief description

The R&S®SMR50/60 are designed as CW generators with pulse modulation capability. Offering an excellent price/performance ratio, each of the models is ideal for economical measuring setups in the field of microwave testing up to 60 GHz at an affordable price. Should the measurement tasks become more demanding, both models can be upgraded any time by means of options to give an AM/FM signal generator or a synthesized sweep generator featuring fast, fully synthesized, analog ramp sweep.

## Excellent spectral purity

The R&S®SMR50/60 stands out from other generators for its excellent spectral purity. Advanced frequency synthesis makes for low SSB phase noise and high spurious suppression, both of which are for example prerequisites for reliable receiver measurements. Modern microwave filters in the output path of the instrument ensure excellent harmonics suppression. This is necessary to obtain conclusive results in scalar network analysis measurements.

## High-precision output level

Microwave signal generators are frequently used for calibrating test receivers. This task calls for a highly accurate

and stable output level settable with high resolution. This is ensured by a high-precision, frequency-response-compensated level control for levels higher than  $-20$  dBm. This range can be extended to  $-110$  dB with the optional RF Attenuator R&S®SMR-B18.

## Main features

## Ease of operation

- ◆ High-contrast LC display
- ◆ Online help including IEC/IEEE-bus commands
- ◆ Simple and self-explanatory settings
- ◆ Storage of menu layers
- ◆ One-hand operation with EasyWheel

## Wide frequency range

- ◆ 1 GHz to 50 GHz (R&S®SMR50)
- ◆ 1 GHz to 60 GHz (R&S®SMR60)
- ◆ Extension of lower frequency limit to 10 MHz (option R&S®SMR-B11)
- ◆ Frequency resolution 1 kHz, 0.1 Hz (option R&S®SMR-B3)

## High output power

- ◆ without option R&S®SMR-B18
  - R&S®SMR50  $>+3$  dBm (at 50 GHz)
  - R&S®SMR60  $>0$  dBm (at 60 GHz)
- ◆ with option R&S®SMR-B18
  - R&S®SMR50  $>0$  dBm (at 50 GHz)
  - R&S®SMR60  $>-4$  dBm (at 60 GHz)

## High-precision level control

- ◆ High-precision, frequency-response-compensated level control
- ◆ Setting range extendible to  $-110$  dBm (option R&S®SMR-B18)

## Three instruments in one

- ◆ CW generator with pulse modulation capability (standard version)
- ◆ Signal generator with AM/FM SCAN and LF generator (option R&S®SMR-B5)
- ◆ Synthesized sweep generator with analog ramp sweep (option R&S®SMR-B4)

## Optional pulse generator (R&amp;S®SMR-B14)

- ◆ Operating modes: single pulse, double pulse (automatically or externally triggered), delayed pulse (externally triggered), gate mode (external)
- ◆ Pulse repetition 100 ns to 85 s
- ◆ Pulse width 20 ns to 1 s

## Sweep capabilities

- ◆ Digital RF and level sweep (standard version)
- ◆ Analog ramp sweep (RF sweep, option R&S®SMR-B4)
- ◆ Maximum sweep rate for ramp sweeps min. 600 MHz/ms ( $f > 2$  GHz)
- ◆ Digital sweep of LF generator (with option R&S®SMR-B5)

## Microwave Signal Generators R&S®SMR50/60

- ◆ 10 freely selectable frequency markers for RF sweep
- ◆ Operating modes: automatic, single-shot, manual, externally triggered, linear or logarithmic

### Further features

- ◆ Space for 50 complete instrument setups
- ◆ Compact, lightweight, user-friendly: ideal in the lab and for field applications
- ◆ 3-year calibration cycle

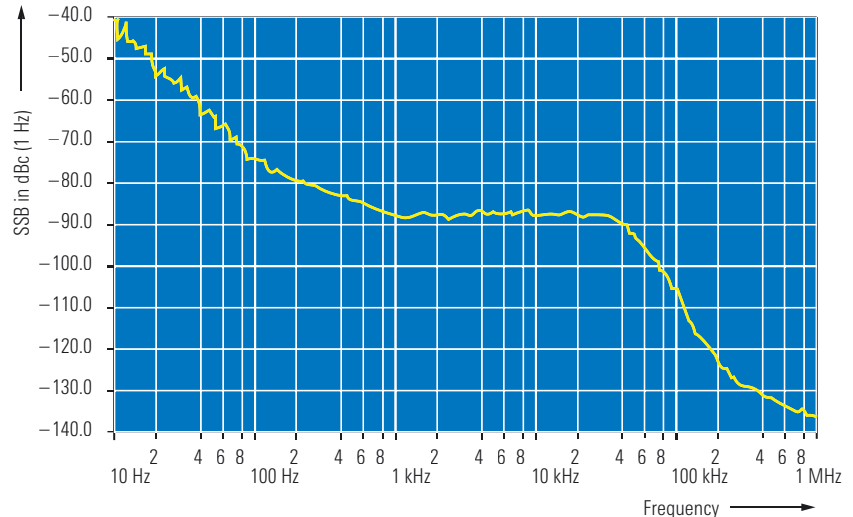

SSB phase noise at 10 GHz

### Specifications in brief

You will find detailed and binding data on the enclosed CD (./DATASHEET/SMR50.pdf), or, for the latest updates, visit [www.rohde-schwarz.com](http://www.rohde-schwarz.com), search term: SMR

<b>Frequency</b>	
R&S®SMR50	
Without option R&S®SMR-B11	1 GHz to 50 GHz
With option R&S®SMR-B11	10 MHz to 50 GHz
R&S®SMR60	
Without option R&S®SMR-B11	1 GHz to 60 GHz
With option R&S®SMR-B11	10 MHz to 60 GHz
Resolution w.o./with option R&S®SMR-B3	1 kHz/0.1 Hz
<b>Spectral purity</b>	
Harmonics <sup>1)</sup>	
10 MHz ≤ f ≤ 30 MHz	<-50 dBc
30 MHz < f ≤ 20 GHz	<-55 dBc
f > 20 GHz <sup>2)</sup>	<-40 dBc
Subharmonics, f ≤ 20 GHz	
Subharmonics, f > 20 GHz	<-65 dBc
Subharmonics (carrier offset > 50 kHz)	
f ≤ 20 GHz	<-60 dBc
20 GHz < f ≤ 40 GHz	<-54 dBc
f > 40 GHz	<-52 dBc
SSB phase noise (f = 10 GHz, 10 kHz from carrier, 1 Hz bandwidth, CW, FM off)	
	<-83 dBc
<b>Level</b>	
Maximum level <sup>3)</sup>	
Frequency range	
0.01 GHz ≤ f < 1 GHz	w.o./with option R&S®SMR-B18
1 GHz ≤ f < 18 GHz	>+11 dBm
18 GHz ≤ f < 20 GHz	>+8 dBm/>+7 dBm
20 GHz < f ≤ 27 GHz	>+7 dBm/>+5 dBm
27 GHz < f ≤ 30 GHz	>+11 dBm/>+9 dBm
30 GHz < f ≤ 40 GHz	>+9 dBm/>+7 dBm
40 GHz < f ≤ 50 GHz	>+7 dBm/>+5 dBm
50 GHz < f ≤ 60 GHz	>+3 dBm/>+0 dBm
	>0 dBm/>-4 dBm

Minimum level of all models	
Without option R&S®SMR-B18	-20 dBm
With option R&S®SMR-B18	-110 dBm
Total deviation (level = -4 dBm)	
f ≤ 20 GHz	<1 dB
20 GHz < f ≤ 40 GHz	<1.4 dB
f > 40 GHz	<1.8 dB
Frequency response (level = -4 dBm)	
f ≤ 20 GHz <sup>4)</sup>	<0.5 dB, typ. <±0.3 dB
20 GHz < f ≤ 40 GHz	<0.7 dB, typ. <±0.4 dB
f > 40 GHz	<0.9 dB, typ. <±0.5 dB
Setting time after IEC/IEEE-bus delimiter	
With option R&S®SMR-B18, with switching in attenuator	<10 ms
	<25 ms
Range for non-interrupting level setting	
	>16 dB
<b>Linear amplitude modulation (option R&amp;S®SMR-B5)</b>	
Operating modes	intern, extern AC/DC
Modulation depth <sup>5)</sup>	0% to 100%
<b>Logarithmic amplitude modulation (option R&amp;S®SMR-B5 (SCAN AM))</b>	
Operating modes	internal, external
Dynamic range	>20 dB
Sensitivity	±0.1 dB/V to ±10 dB/V
Rise/fall time (10%/90%)	<10 μs
<b>Frequency modulation (option R&amp;S®SMR-B5)</b>	
Operating modes	internal, external AC/DC
Maximum deviation	
f ≤ 15.625 MHz	39.0625 kHz
15.625 MHz < f ≤ 31.25 MHz	78.125 kHz
ranges increased by a factor of 2	increased by a factor of 2
20 GHz < f ≤ 40 GHz	40 MHz
f > 40 GHz	80 MHz
Modulation frequency range	DC to 5 MHz
<b>ASK modulation</b>	
Modulation frequency range	external, option R&S®SMR-B5
Maximum modulation depth	90%
Data rate, f < 1 GHz	0 Hz to 100 kHz
Data rate, f ≥ 1 GHz	0 Hz to 200 kHz
Rise/fall time (10%/90%), f < 1 GHz	<10 μs
Rise/fall time (10%/90%), f ≥ 1 GHz	<5 μs



Contents Overview

Chapter Overview

Type Index

R&amp;S Addresses



## Microwave Signal Generators R&amp;S®SMR50/60

<b>FSK modulation</b>	external, <b>option R&amp;S®SMR-B5</b>
Maximum deviation	
f ≤15.625 MHz	39.0625 kHz
15.625 MHz < f ≤31.25 MHz	78.125 kHz
ranges increased by a factor of 2	increased by a factor of 2
20 GHz < f ≤40 GHz	40 MHz
f >40 GHz	80 MHz
Data rate	0 Hz to 2 MHz
Rise/fall time (10%/90%)	<500 ns
<b>Pulse modulation</b>	external, internal <b>option R&amp;S®SMR-B14</b>
On/off ratio	>80 dB
On/off ratio (10%/90%), f >450 MHz	<12 ns <sup>6)</sup>
Minimum pulse width (ALC OFF)	25 ns
Maximum pulse pause (ALC OFF)	any
With level control off (ALC OFF)	any
Maximum pulse repetition frequency	
f >450 MHz	10 MHz
Pulse delay	typ. 50 ns
Video feedthrough V <sub>DD</sub>	<20 mV
<b>Simultaneous modulation</b>	
FM (FSK) is independent of AM (SCAN AM, ASK) and pulse modulation. Reduced AM bandwidth for simultaneous AM (SCAN AM, ASK) and pulse modulation.	
<b>LF generator</b>	<b>option R&amp;S®SMR-B5</b>
Frequency range	0.1 Hz to 10 MHz
Waveforms	sinewave, squarewave
Frequency response (up to 500 kHz)	<0.5 dB
Distortion (up to 100 kHz)	<0.5% (R <sub>L</sub> >200 Ω, level = 0.5 V)
<b>Pulse generator</b>	<b>option R&amp;S®SMR-B14</b>
Operating modes	single or double pulse (automatically or externally triggered), delayed pulse (externally triggered), gate mode (external)
Active trigger edge	positive or negative
Pulse repetition period	100 ns to 85 s
Pulse width	20 ns to 1 s
Pulse delay	20 ns to 1 s
Double pulse	60 ns to 1 s
Trigger delay	typ. 50 ns
<b>Digital sweep, sweep in discrete steps</b>	
RF sweep, AF sweep	
Operating modes	automatic, single-shot, manual or externally triggered, logarithmic
Sweep range	freely selectable
Step width (lin)	freely selectable
Step width (log)	0.01% to 100%
Step time	10 ms to 5 s
Level sweep	
Operating modes	automatic, single-shot, manual or externally triggered, logarithmic
Sweep range	0 dB to ≥16 dB
Step width	0.01 dB to 20 dB
Step time	1 ms to 5 s
Markers	10, freely selectable
<b>Ramp sweep</b>	<b>option R&amp;S®SMR-B4</b>
RF sweep	automatic, single-shot, manual or externally triggered
Operating modes	Start/Stop, center frequency/span
Sweep range	freely selectable, increasing
Sweep time <sup>1)</sup>	10 ms to 100 s

Max. sweep rate	
f ≤15.625 MHz	2.34375 MHz/ms
15.625 MHz < f ≤31.25 MHz	4.6875 MHz/ms
ranges increased by a factor of 2	increased by a factor of 2
20 GHz < f ≤40 GHz	2400 MHz/ms
f >40 GHz	4800 MHz/ms
Markers	10, freely selectable
<b>List mode</b>	
Frequency and level values can be stored in a list.	
Permissible level variation	max. 20 dB
Operating modes	auto, single-shot, manual or external trigger
Maximum number of frequency/level entries	2003
Maximum number of lists	up to 10
Step time	1 ms to 5 s
<b>General data</b>	
Storable instrument setups	50
Remote control	IEC 625-1 (IEEE 488.1)
Rated temperature range	0°C to +55°C
Power supply	100 to 120 V (AC), 50 Hz to 400 Hz, 200 V to 240 V (AC), 50 to 60 Hz, autoranging, max. 300 VA
Dimensions (W × H × D)	426.7 mm × 131.4 mm × 450 mm
Weight	<13.5 kg when fully equipped

- 1) R&S®SMR50: level <0 dBm. SMR60: level <0 dBm for f ≤50 GHz or <-4 dBm for f >50 GHz.
- 2) Specifications for harmonics above 50 GHz (R&S®SMR50) and 60 GHz (R&S®SMR60) only typical.
- 3) Maximum level is reduced by up to 2 dB in the temperature range 35°C to 55°C.
- 4) From 10 MHz to 50 MHz, the specified total deviation is only valid in the temperature range 15°C to 35°C. The deviation outside this temperature range is likely to be higher by max. 0.7 dB.
- 5) The modulation depth adjustable within the AM specifications continuously decreases from 6 dB below the maximum level up to the maximum level.
- 6) ≤30 ms switching time at 1 GHz, 2 GHz, 10 GHz, 20 GHz and 40 GHz.

## Ordering information

<b>Microwave Signal Generator</b>	R&S®SMR50	1134.9008.50
	R&S®SMR60	1134.9008.60
<b>Accessories supplied</b>	Power cable, operating manual	
<b>Options</b>		
OXCXO Reference Oscillator	R&S®SMR-B1	1104.5485.02
Frequency Resolution 0.1 Hz	R&S®SMR-B3	1104.5585.02
Ramp Sweep	R&S®SMR-B4	1104.5685.02
AM/FM/Scan Modulator	R&S®SMR-B5	1104.3501.03
Frequency Extension 0.01 GHz to 1 GHz <sup>1)</sup>	R&S®SMR-B11	1104.4250.60
Pulse Generator	R&S®SMR-B14	1104.3982.02
RF Attenuator <sup>1)</sup>	R&S®SMR-B18	1135.2907.02
Rear Connectors for AF	R&S®SMR-B21	1135.2407.02
<b>Extras</b>		
Service Kit	R&S®SMR-Z1	1103.9506.02
Interface Cable	R&S®SMR-Z3	1134.9772.02
19" Rack Adapter	R&S®ZZA-311	1096.3277.00

- 1) Factory-fitted option.



Contents Overview

Chapter Overview

Type Index

R&amp;S Addresses



## I/Q Modulation Generator R&S® AMIQ

### 16 Msample

### New approaches in the generation of complex I/Q signals



### Brief description

I/Q Modulation Generator R&S® AMIQ04 and Simulation Software R&S® WinIQSIM™ open up new dimensions for the generation of I/Q signals. R&S® AMIQ is a dual-channel modulation generator that has consequently been designed for use as an I/Q source. It is programmed and set with Software R&S® WinIQSIM™. Alternatively, R&S® AMIQ can be operated from a Vector Signal Generator R&S® SMIQ.

Each channel can store 16 000 000 samples respectively. Even at high symbol rates sequences of sufficient length can thus be generated. With clock frequencies of up to 100 Msample/s and a high amplitude resolution of 14 (up to 16 bits via digital I/Q output) bits, R&S® AMIQ is the ideal source for any signal in the world of digital modulation. An automatic amplitude/offset alignment as well as fine adjustment of the skew provide excellent symmetry of the two channels which previously was extremely difficult to attain with dual-channel ARB generators. The error vector can thus be minimized. A typ-

ical application of R&S® AMIQ and R&S® WinIQSIM™ is not only to drive the I/Q inputs of a vector signal generator. This combination is also ideal for direct applications in the baseband, e.g. for testing I/Q modulators/demodulators.

### Main features

#### R&S® AMIQ

- ◆ 14-bit resolution (up to 16 bits via digital I/Q output)
- ◆ 16 000 000 samples memory depth
- ◆ 100 MHz sample rate
- ◆ Integrated hard disk and FDD
- ◆ Optional BER measurement
- ◆ Optional differential I/Q outputs
- ◆ Optional digital I/Q output

#### R&S® WinIQSIM™

- ◆ Calculation of digitally modulated I/Q and IF signals
- ◆ Single-carrier, multicarrier and CDMA, WCDMA 3GPP and W-LAN signals
- ◆ Import of I/Q signals via DDE interface
- ◆ Versatile data editor
- ◆ Superposition/simulation of impairments
- ◆ Graphic display

### I/Q simulation software

Modulation methods like GMSK or  $\pi/4$ DQPSK are used in mobile communication systems such as GSM (Global System for Mobile Communications) or NADC (North American Digital Cellular). These complex modulation modes are usually generated with the aid of an I/Q or vector modulator. The calculation and generation of the required baseband signals is of course quite complex.

R&S® WinIQSIM™ is a Windows software allowing calculation of I and Q baseband signals. Its capabilities range from single-carrier modulation, generation of multicarrier, CDMA and WCDMA signals through to TDMA frame configurations with the help of a convenient data editor. All modulation parameters and impairments can be simulated for single-carrier and multi-carrier as well as for CDMA signals. To put it in a nutshell: R&S® WinIQSIM™ is an indispensable tool for anyone engaged in modern digital modulation.

### Specifications in brief

You will find detailed and binding data on the enclosed CD (./DATASHEET/AMIQ.pdf), or, for the latest updates, visit [www.rohde-schwarz.com](http://www.rohde-schwarz.com), search term: AMIQ

Output memory	
Waveform length (data and markers)	
Clock rate	
Slow mode, 10 Hz to 4 MHz	24 to 16 000 000 in steps of one
Fast mode, 2 MHz to 100 MHz	24 to 16 000 000 in steps of four
Amplitude resolution of data words	selectable word length 8 bit to 14 bit; up to 16 bit at digital output
Marker channels	4, can be used as marker or trigger outputs (for word lengths up to 14 bit)





Contents Overview

Chapter Overview

Type Index

R&amp;S Addresses



## I/Q Modulation Generator R&amp;S® AMIQ

<b>Multisegment waveform</b>	max. 30 segments
Segment changeover time	
without clock change	typ. 4 ms
with clock change	typ. 12 ms
<b>Signal output</b>	I and Q
Output voltage ( $V_p$ into 50 $\Omega$ )	
Fix mode	0.5 V, same for both channels
Variable mode	0 V to 1 V, separately adjustable for each channel
Skew between I and Q channel (filter off, clock rate 10 MHz, fix mode)	
Fine variation	typ. $\pm 1$ ns
<b>Adjacent-channel power</b>	
WCDMA 3GPP FDD	
Test model 1 (64 DPCH channels)	
Offset 5 MHz, 10 MHz	typ. -78 dBc
<b>Error vector</b>	
IS-95 (QPSK)	typ. 0.35% EVM (rms)
GSM (GMSK)	typ. 0.2° phase error (rms)
DECT (2-FSK)	typ. 0.9% FSK error
NADC, PHS ( $\pi/4$ DQPSK)	typ. 0.3% EVM (rms)
<b>Filters</b>	
Operating modes	off (no filter), internal or external filter
Internal filters, 25 MHz	elliptic, 7th order + delay equalizer
Freq. response, amplitude	typ. 0.15 dB up to 25 MHz
Freq. response, group delay	typ. 500 ps up to 20 MHz
Internal filters, 2.5 MHz	elliptic, 7th order + delay equalizer
Freq. response, amplitude	typ. 0.15 dB up to 2.5 MHz
Freq. response, group delay	typ. 5 ns up to 2 MHz
External filters	one filter can be connected for each channel, BNC connectors on rear panel
<b>Trigger</b>	
CONT mode	repetitive output of loaded waveform after occurrence of trigger
SINGLE mode	single output of loaded waveform after occurrence of trigger
GATED mode	start of (repetitive) waveform output after occurrence of trigger until end of trigger event
Trigger signal	via remote control or trigger input
<b>Marker outputs</b>	4, BNC connectors
<b>BER measurement (option R&amp;S® AMIQ-B1)</b>	
Data supplied by the DUT can be compared with a nominal random bit sequence; the results are transferred to the host computer (via the currently used remote control); the BER measurement can be controlled from R&S® WinIQSIM™ and R&S® SMIQ.	
Pseudo random bit sequences	$2^q-1$ , $2^{11}-1$ , $2^{15}-1$ , $2^{16}-1$ , $2^{20}-1$ , $2^{21}-1$ , $2^{23}-1$
Measurement time	selectable through max. number of data or error bits (max. $2^{31}$ bit), continuous measurement
Measurement results	BER in ppm (when set number of data or error bits is attained), not synchronized, no clock from DUT
<b>Differential I/Q outputs (option R&amp;S® AMIQ-B2)</b>	
Provides the inverted $\bar{I}$ and $\bar{Q}$ signals and allows a DC voltage to be simultaneously superimposed on the output signal.	
Outputs	I, $\bar{I}$ , Q and $\bar{Q}$
Operating mode	single/differential, selectable
Bias voltage (EMF, to ground)	-2.5 V to +2.5 V ( $\pm 10$ mV) for both I and Q channels separate, common setting for I and $\bar{I}$ or Q and $\bar{Q}$

Output voltage (differential EMF between the I and $\bar{I}$ or Q and $\bar{Q}$ outputs, unless otherwise specified, $V_D$ )	
Fix mode	2 V, same for both I and Q channels
DC fine variation	typ. $\pm 120$ mV
Variable mode	0 V to 4 V, separately adjustable for I and Q channels
DC fine variation	typ. $\pm 280$ mV
<b>Digital I/Q output (option R&amp;S® AMIQ-B3)</b>	
Channels	I and Q
Resolution	8 bit to 16 bit (selectable, no marker output for word lengths > 14 bit)
Output level	LVT or ABT level (data, marker and clock); the high level of the data, marker and clock signals is automatically adapted to the selected supply voltage for external circuits
$V_{cc}$ output	+3.3 V or +5 V
<b>Remote control and memory</b>	via IEC 60625 (IEEE 488) and RS-232-C
Mass memory	FDD (3.5", 1.44 MB), hard disk
Download time (4000000 I/Q samples from built-in hard disk)	27 s
<b>General data</b>	
Operating temperature range	+5°C to +45°C
Power supply	100 V to 120 V $\pm 10\%$ , 50 Hz to 400 Hz, 200 V to 240 V $\pm 10\%$ , 50 Hz to 60 Hz, autoranging, 150 VA
Dimensions (W x H x D)	427 mm x 88 mm x 450 mm
Weight	8.7 kg

## Ordering information

<b>I/Q Modulation Generator</b>		
16 Msamples	R&S® AMIQ	1110.2003.04
<b>Accessories supplied</b>		
R&S® WinIQSIM™ version for Windows 95/98/NT/2000 on CD-ROM; manual, power cable, R&S® AMIQ operating manual		
<b>Options</b>		
BER Measurement	R&S® AMIQ-B1	1110.3500.02
Differential I/Q Outputs	R&S® AMIQ-B2	1110.3700.03
Digital I/Q Output	R&S® AMIQ-B3	1122.2103.02
Rear I/Q Outputs	R&S® AMIQ-B19 <sup>1)</sup>	1110.3400.02
Digital Standards		
IS-95	R&S® AMIQK11	1122.2003.02
CDMA2000	R&S® AMIQK12	1122.2503.02
WCDMA TDD Mode (3GPP)	R&S® AMIQK13	1122.2603.02
TD-SCDMA	R&S® AMIQK14	1122.2703.02
1xEV-DO	R&S® AMIQK17	1122.3000.02
IEEE802.11	R&S® AMIQK19	1122.3200.02
3GPP FDD incl. HSDPA	R&S® AMIQK20	1122.3200.02
OFDM Signal Generation	R&S® AMIQK15	1122.2803.02
<b>Recommended extra</b>		
19" Rack Adapter	R&S® ZZA-211	1096.3260.00

- 1) Data at clock > 100 MHz are not warranted, max. environment temperature 35 °C.
- 2) Marker outputs 3 and 4 not provided if this option is fitted, R&S® AMIQ-B19 not suitable in conjunction with R&S® AMIQ-B2.
- 3) R&S® WinIQSIM™ required.



Contents Overview

Chapter Overview

Type Index

R&amp;S Addresses





## Simulation Software R&S® WinIQSIM™

### Ideal for the generation of digitally modulated signals

#### Brief description

R&S® WinIQSIM™ was especially developed for the generation of digitally modulated signals. Complex signals can thus easily be generated. The graphical user interface allows intuitive operation, supported by context-sensitive help. The convenient way of creating any TDMA frame configurations with the aid of a data editor, and the generation of multicarrier signals as well as of complex WCDMA signals make R&S® WinIQSIM™ suitable for a wide range of applications. Moreover, additive impairments can be superimposed on a signal.

The signals generated with the aid of the R&S® WinIQSIM™ software can be output by the integrated solution in the R&S® SMU (option R&S® SMU-B10) and the R&S® SMIQ (option R&S® SMIQB60) as well as the I/Q Modulation Generator R&S® AMIQ. R&S® WinIQSIM™ is provided with these three arbitrary waveform generators free of charge.

#### Main features

- ◆ Calculation of digitally modulated I/Q and IF signals
- ◆ For driving the internal arbitrary waveform generator of the R&S® SMU (R&S® SMU-B10), the R&S® SMIQ (R&S® SMIQB60) and the I/Q Modulation Generator R&S® AMIQ
- ◆ Single-carrier, multicarrier, multi-carrier mixed signals and CDMA signals

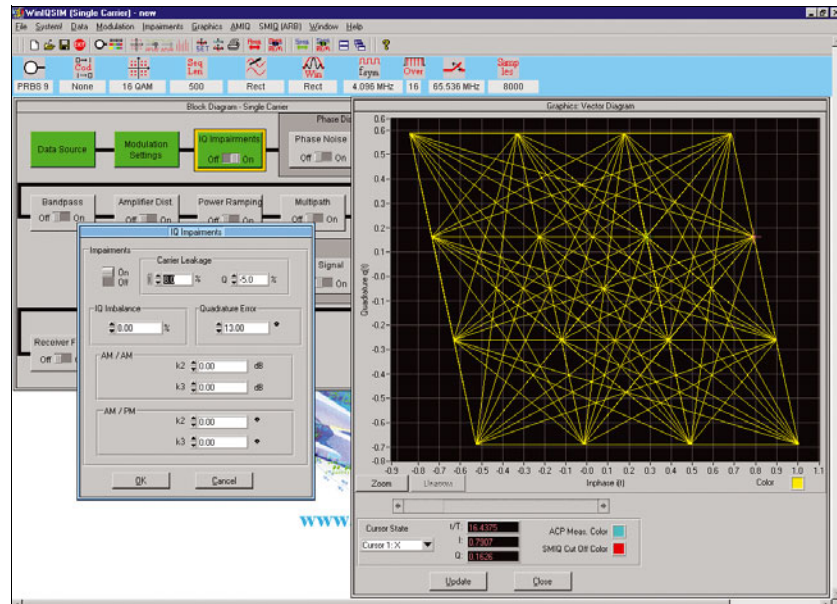

*Simulation of I/Q impairments, here for 16QAM*

- ◆ 3GPP FDD mode including data sets for the test models to 3GPP
- ◆ 3GPP FDD mode including HSDPA (R&S® SMU-K20/R&S® SMIQK20/R&S® AMIQK20)
- ◆ 3GPP TDD mode optional (R&S® SMU-K13/SMIQK13/AMIQK13)
- ◆ TD-SCDMA optional (R&S® SMU-K14/ SMIQK14/AMIQK14)
- ◆ IS-95 CDMA optional (R&S® SMU-K11/ SMIQK11/AMIQK11)
- ◆ cdma2000 optional (R&S® SMU-K12/ SMIQK12/AMIQK12)
- ◆ Versatile data editor
- ◆ Superposition/simulation of impairments
- ◆ Graphical display
- ◆ Can be enhanced by import interface for additional software
- ◆ 1xEV-DO optional (R&S® SMU-K17/SMIQK17/AMIQK17)
- ◆ IEEE802.11 (a,b,g) optional (R&S® SMU-K19/SMIQK19/AMIQK19)

#### Characteristics

##### Install it and go ahead

In developing R&S® WinIQSIM™, great importance was attached to user-friendly operation. The main parameters of a signal, for example, are indicated in a status line. The context-sensitive online help enables handling of even complex functions without consulting the manual.

The program always starts with the settings of the previous session, thus ensuring easy continuation of work.

##### Import system

Data from other PC programs can be read in via the import system. The TCP/IP or the dynamic data exchange (DDE) interface serves as the software interface.

Data can, for example, be imported from the R&S® WinIQOFDM software, which is used for generating OFDM-modulated signals. Through subsequent processing





Contents Overview

Chapter Overview

Type Index

R&amp;S Addresses



## Simulation Software R&amp;S® WinIQSIM™

in R&S® WinIQSIM™, signal modifications such as baseband filtering and superimposed impairments can be applied to the signal to be generated.

The import interface also forms the basis for further applications (e.g. R&S® IQWizard, for more information see [www.rohde-schwarz.com](http://www.rohde-schwarz.com)) or customer-specific enhancements.

**Remote-control functions**

The R&S® WinIQSIM™ PC program is used to control and operate the internal arbitrary waveform generators of R&S® SMU (R&S® SMU-B10), R&S® SMIQ (R&S® SMIQB60) and the I/Q Modulation Generators R&S® AMIQ. For the R&S® AMIQ, it provides file management on the internal hard disk, and controls the hardware settings and all other functions.

The functionality of R&S® WinIQSIM™ regarding device control is especially important in bit error rate measurements with the R&S® AMIQ (option R&S® AMIQ-B1). In addition to performing the control functions, the software outputs the measurement results in an R&S® WinIQSIM™ window.

## Specifications in brief

**You will find detailed and binding data on enclosed CD (./DATASHEET/WinIQSIM.pdf) or top current on our web page: [www.rohde-schwarz.com](http://www.rohde-schwarz.com), search term: WinIQSIM**

User interface	Windows interface with context-sensitive help
Systems	single-carrier, multicarrier, multicarrier mixed signal, 3GPP FDD, 3GPP TDD, TD-SCDMA, IS-95, cdma2000

**Single carrier**

Simulation of digitally modulated single-carrier signals incl. TDMA	
Modulation modes	PSK
Parameter	BPSK, QPSK, offset QPSK, $\pi/4$ DQPSK, 8PSK, 8PSK EDGE reference level = -10 dB to 3 dB PSK rotation = 0 to $15 \times \pi/8$
QAM	16/32/64/256QAM
Parameter	reference level = -10 dB to 3 dB
FSK	MSK, 2FSK, 4FSK, GTFM
Parameter	modulation index = 0.1 to 12 GTFM, b = 0 to 1
User-specific modulation	definition of customized modulation modes (PSK, QAM, FSK) via data interface with up to 4.096 mapping states

**Multicarrier**

Simulation of multicarrier signals with same or without modulation	
Number of carriers	max. 512 carriers
Parameters of each carrier	state on/off, power, modulation on/off, data source, start phase
Modulation modes	same as with single-carrier system, each carrier can be modulated or not, modulated carriers use the same modulation mode

**Multicarrier mixed signal**

Simulation of differently modulated multicarrier signals and signals of different systems on the carriers	
Number of carriers	max. 32
Parameters of each carrier	state on/off, power, I/Q modulation file, start phase
I/Q modulation signal	an I/Q signal file onto which the carrier is to be modulated can be defined for each carrier; these signal files can be generated in all systems

**Digital standard 3GPP FDD****with option R&S® SMU-K20/R&S® SMIQK20/R&S AMIQK20**

Release 5 to 3GPP Technical Specifications TS25.211, TS25.213, TS25.141, TS25.101 and TS25.104

**General settings**

Chip rate, standard	3.840 Mcps (15 slots/frame)
Chip rate, range	10 cps to 100 Mcps
Link direction	uplink (reverse link) and downlink (forward link)

**Digital standard 3GPP TDD****with option R&S® SMU-K13/R&S® SMIQK13/R&S AMIQK13**

Simulation of signals to time division duplex wideband CDMA standard according to version 4.1.0 of the 3GPP Technical Specification TS 25.221, TS 25.223, available as Software Option R&S® SMU-K13 and internal Arbitrary Waveform Generator of Option R&S® SMU-B10 of the R&S® SMU or Software Option R&S® SMIQK13 and Arbitrary Waveform Generator Option R&S® SMIQB60 of the R&S® SMIQ or Software Option R&S® AMIQK13 of the R&S® AMIQ

**General settings**

Chip rate, standard	3.84 Mcps
Chip rate, range	see clock rates of R&S® SMU-B10/R&S® SMIQB60/R&S® AMIQ in the corresponding datasheets
Mode	downlink only: the base station components of a cell are active uplink only: the mobile station components of a cell are active downlink and uplink: both the base station and the mobile station components of a cell are active

**Digital standard TD-SCDMA****with option R&S® SMU-K14/R&S® SMIQK14/R&S AMIQK14**

Simulation of signals according to time division synchronous CDMA standard of China Wireless Telecommunication Standard Group (CWTS), available as Software Option R&S® SMU-K14 and internal Arbitrary Waveform Generator of Option R&S® SMU-B10 of the R&S® SMU or Software Option R&S® SMIQK14 and Arbitrary Waveform Generator Option R&S® SMIQB60 of the R&S® SMIQ or Software Option R&S® AMIQK14 of the R&S® AMIQ

**General settings**

Chip rate	1.28 Mcps
Standard	
Range	see clock rates of R&S® SMU-B10/R&S® SMIQB60/R&S® AMIQ in the corresponding datasheets
Mode	downlink only: the base station components of a cell are active uplink only: the mobile station components of a cell are active downlink and uplink: both the base station and the mobile station components of a cell are active



Contents Overview

Chapter Overview

Type Index

R&amp;S Addresses





Contents Overview

Chapter Overview

Type Index

R&S Addresses



## Simulation Software R&S® WinIQSIM™

### Digital standard IS-95

with option R&S®SMU-K11/R&S®SMIQK11/R&S®AMIQK11

Simulation of CDMA signals to North American standard cdmaOne, available as Software Option R&S®SMU-K11 and internal Arbitrary Waveform Generator or Software Option R&S®SMIQK11 in conjunction with the Arbitrary Waveform Generator Option R&S®SMIQB60 of the R&S®SMIQ or Option R&S®SMU-B10 of the R&S®SMU or Software Option R&S®AMIQK11 of the R&S®AMIQ

#### General settings

Chip rate, standard Range	1.2288 Mcps see clock rates of R&S®SMU-B10/R&S®SMIQB60/R&S®AMIQ in the corresponding datasheets
Link direction	forward link and reverse link

### Digital standard cdma2000

with option R&S®SMU-K12/R&S®SMIQK12/R&S®AMIQK12

Simulation of CDMA signals to North American standard IS-2000, available as Software Option R&S®SMU-K12 and internal Arbitrary Waveform Generator of Option R&S®SMU-B10 of the R&S®SMU or Software Option R&S®SMIQK12 in conjunction with the Arbitrary Waveform Generator Option R&S®SMIQB60 of the R&S®SMIQ or Software Option R&S®AMIQK12 of the R&S®AMIQ

#### General settings

Chip rate, standard Range	1.2288 Mcps (1X), 3.6864 Mcps (3X) see clock rates of R&S®SMU-B10/R&S®SMIQB60/R&S®AMIQ in the corresponding datasheets
Carrier spacing, standard Variable	1.25 MHz R&S®AMIQ: 0 to 10 MHz, R&S®SMIQB60: 0 to 2 MHz
Modes	1X Direct Spread, 3X Direct Spread 3X Multi Carrier (forward link only)
Link direction	forward link and reverse link

### Digital standard 1xEV-DO

with option R&S®SMU-K17/R&S®SMIQK17/R&S®AMIQK17

Simulation of 1xEV-DO signals to North American Standard "cdma2000 High Rate Packet Data Air Interface Specification", available as Software Option R&S®SMU-K17 and internal Arbitrary Waveform Generator of Option R&S®SMU-B10 of the R&S®SMU or Software Option R&S®SMIQK17 in conjunction with the Arbitrary Waveform Generator Option R&S®SMIQB60 of the R&S®SMIQ or Software Option R&S®AMIQK17 of the R&S®AMIQ

#### General settings

Chip rate, standard Range	1.2288 Mcps see clock rates of R&S®SMU-B10/R&S®SMIQB60/R&S®AMIQ in the corresponding datasheets
Link direction	forward link (simulation of up to 4 base stations) and reverse link (simulation of up to 4 mobiles)

### Digital standard IEEE 802.11(a,b,g) Wireless LAN

with option R&S®SMU-K19/R&S®SMIQK19/R&S®AMIQK19

Simulation of signals to Wireless LAN standard IEEE802.11, available as Software Option R&S®SMU-K19 and Option R&S®SMU-B10 of R&S®SMU or Software Option R&S®SMIQK19 and Option R&S®SMIQB60 Arbitrary Waveform Generator of R&S®SMIQ or Software Option R&S®AMIQK19 of R&S®AMIQ

The wireless LAN options R&S®SMU-K19/SMIQK19/AMIQK19 support CCK modulation to IEEE802.11b and 802.11g, OFDM modulation to IEEE802.11a and 802.11g as well as extended PBCC modes to IEEE802.11b and 802.11g.

#### Settings valid for 11b, 11g and 11a

Simulation mode Framed mode	generation of a sequence of data packets with the frame structure defined by the standard, interrupted by an idle time
Unframed mode	generation of a non-packet-oriented signal without frame structure, with the modulation modes and data rates defined by the 802.11 standard
User data	same as with single-carrier system

### Import system

Import of I/Q data from other applications via a dynamic data exchange (DDE) interface or via TCP/IP; further processing in R&S®WinIQSIM™, e.g. baseband filtering or superposition of impairments

Baseband filtering	same as with single-carrier system
Sequence length	R&S®SMU-B10: 1 sample to max. 56 Msample R&S®SMIQB60: 1 sample to max. 524.216 Msample R&S®AMIQ04: 1 sample to max. 16 Msample
Simulation of impairments and transfer characteristics	same as with single-carrier system
Smoothing	same as with single-carrier system
Graphical output	same as with single-carrier system
ACP calculation	calculation of adjacent-channel power in spectrum display (ACP up, low and ACP up 1st alt, low 1st alt)
IF signal generation	modulation of calculated I/Q signal to IF in range 0.01 MHz to 25 MHz (output to I channel of R&S®AMIQ)

### Miscellaneous

Waveform transmission to R&S®AMIQ	interfaces: IEC/IEEE bus (GPIB), RS-232-C, floppy; conversion of I/Q signal to 14 bit R&S®AMIQ format: user-selectable clipping level (over- and underranging possible)
Remote control of R&S®AMIQ	download and starting of waveforms, hardware configuration, alignment and fine adjustment, file management, BER test
For data transfer	IEC/IEEE bus (GPIB): card (from National Instruments) with drivers, IEC/IEEE bus cable; RS-232-C null-modem cable
System requirements	PC, 50 Mbyte hard disk memory, mouse, monitor: 1024 × 768 pixels with 256 colours recommended

## Ordering information

<b>Baseband Generator with ARB</b> (56 Msample) and Digital Modulation	R&S®SMU-B10	1141.7007.02
<b>Internal Arbitrary Waveform Generator</b> in the R&S®SMIQ	R&S®SMIQB60	1136.4390.02
<b>I/Q Modulation Generator</b>	R&S®AMIQ	1110.2003.04
<b>Digital Standards</b>		
IS-95 (cdmaOne)	R&S®SMU-K11 R&S®SMIQK11 R&S®AMIQK11	1160.5335.02 1105.0287.02 1122.2003.02
cdma2000	R&S®SMU-K12 R&S®SMIQK12 R&S®AMIQK12	1160.5658.02 1105.0435.02 1122.2503.02
3GPP TDD	R&S®SMU-K13 R&S®SMIQK13 R&S®AMIQK13	1160.5906.02 1105.1231.02 1122.2603.02
3GPP FDD	R&S®SMU-K20 R&S®SMIQK20 R&S®AMIQK20	1160.9460.02 1400.5302.02 1400.5354.02
1xEV-DO	R&S®SMU-K17 R&S®SMIQK17 R&S®AMIQK17	1160.7009.02 1154.7800.02 1122.3000.02
TD-SCDMA	R&S®SMU-K14 R&S®AMIQK14 R&S®SMIQK14	1160.6202.02 1122.2703.02 1105.1383.02
OFDM Signal Generation	R&S®SMU-K15 R&S®AMIQK15 R&S®SMIQK15	1160.6402.02 1122.2803.02 1105.1531.02
IEEE802.11 (a,b,g)	R&S®SMU-K19 R&S®SMIQK19 R&S®AMIQK19	1160.8805.02 1154.8307.02 1122.3200.02



Contents Overview

Chapter Overview

Type Index

R&S Addresses







Contents Overview

Chapter Overview

Type Index

R&amp;S Addresses



## Dual-Channel Arbitrary/Function Generator R&amp;S®AM300

Arbitrary, function and  
I/Q generator

- 100 Msample/s
- DC up to 50 MHz

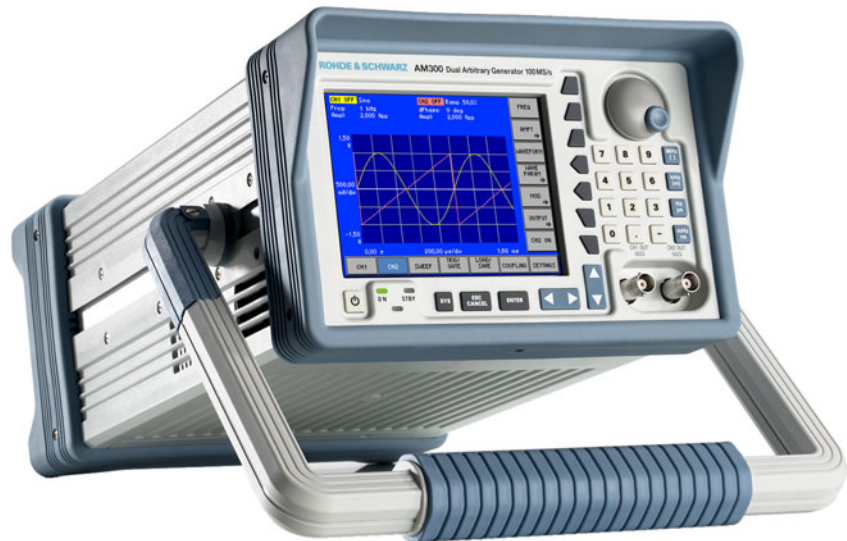
**New**

## Brief description

The R&S®AM300 is a dual-channel arbitrary/function generator that offers superb functionality and spectral purity at a favourable price. Due to its high-quality characteristics, the instrument displays digitally generated signals almost distortion-free – even at high output levels and frequencies. The R&S®AM300 thus meets reference signal source requirements for a host of applications.

With a high sampling rate of up to 100 Msample/s, 256k-point waveform memory per channel and the Waveform Composer software, virtually any waveform can be implemented – no matter whether for applications in the lab, in production or service.

The two channels of the instrument are phase-coupled and thus allow the generation of analog I/Q signals that can be used, for example, to modulate the RF Signal Generator R&S®SM300. The upper frequency limit of 35 Hz for sine signals

and 50 MHz for square signals leaves sufficient room for future tasks.

Operation is menu-guided so that even untrained users will quickly obtain correct results. Clear structures simplify navigation within the menus. The bright TFT colour display allows settings and results to be read even at odd angles or when the incidence of light is unfavourable.

## Main features

- ◆ Two channels with individually selectable frequency, waveform and amplitude
- ◆ Phase offset selectable with 0.01° resolution
- ◆ Harmonic suppression for sine signals (1 MHz), typically 70 dB (0.03%)
- ◆ Large colour display for displaying waveforms, including zoom function
- ◆ Highly stable reference frequency (1 ppm/year)
- ◆ Low-jitter clock generator up to 50 MHz
- ◆ USB interface (with file management on USB stick)

## Applications

- ◆ Generation of high-quality modulation signals
- ◆ Generation of two signals with precisely defined time and phase relationship
- ◆ Testing of control loops (e.g. AGCs)
- ◆ Generation of test signals, e.g. simulation of sensor signals including defined superimposed interference
- ◆ Replay of digitized data for reproduction of real signals
- ◆ Generation of I/Q modulation signals for generating a wide range of digitally modulated broadband signals
- ◆ Generation of pulses and bursts

The possible combinations offered by the two channels of the R&S®AM300 further increase the instrument's versatility.



Contents Overview

Chapter Overview

Type Index

R&amp;S Addresses





[Contents Overview](#)
[Chapter Overview](#)
[Type Index](#)
[R&S Addresses](#)

## Dual-Channel Arbitrary/Function Generator R&S® AM300

### Specifications in brief

You will find detailed and binding data on the enclosed CD (./DATASHEET/AM300.pdf), or, for the latest updates, visit [www.rohde-schwarz.com](http://www.rohde-schwarz.com), search term: **AM300**

<b>Channels</b>	2
Phase, setting range	
Operating modes	CH1, CH2, CH1+CH2
<b>Waveforms</b>	
Standard	sine, triangle, ramp, square, pulse, exponential rise, exponential fall, noise
Arbitrary	
Waveform length	16 to 262144 (256k) points per channel
Level resolution	14 bit
<b>Modulation</b>	
Modulation modes	AM, FM, $\phi$ M, FSK, PSK
Frequency	
Sine	10 $\mu$ Hz to 35 MHz
Triangle, ramp, square, exponential	10 $\mu$ Hz to 500 kHz
Low-jitter square	10 $\mu$ Hz to 50 MHz
Noise	35 MHz bandwidth
Pulse	10 $\mu$ Hz to 16.667 MHz
<b>Arbitrary</b>	
Repetition rate	max. 6.25 MHz (16 points)
Sampling rate	10 $\mu$ Hz to 100 MHz
<b>Signal output</b>	
Protection	short-circuit-protected
Output voltage (into 50 $\Omega$ )	
Setting range with AM	1 mV to 10 V ( $V_{pp}$ ); 1 mV to 5 V ( $V_{DO}$ )
Resolution	0.1 mV (4 digits)
Frequency response, relative to 10 kHz sinewave, 10 $\mu$ Hz $\leq$ f $\leq$ 30 MHz	$\pm$ 0.1 dB
<b>Filters</b>	
Internal	manual, automatic
Cutoff frequencies of lowpass filters	35 MHz, 37 MHz, 75 MHz
Filter types	9th order Bessel, 9th order Cauer

Modulation	AM	FM	$\phi$ M	FSK	PSK
<b>Carrier waveforms</b>					
Sine	•	•	•	•	•
Triangle	•	•	•	•	•
Square	•	•	•	•	•
Ramp	•	•	•	•	•
Exponential	•	•	•	•	•
Pulse	•				
Arbitrary	•	•	•	•	•
Noise	•				
<b>Modulation waveforms</b>					
Sine	•	•	•		
Triangle	•	•	•		
Square	•	•	•	•	•
Ramp	•	•	•		
Exponential	•	•	•		
Pulse					
Arbitrary					
Noise	•	•	•		
<b>Source</b>					
Internal/external	int.	int.	int.	int./ext.	int./ext.

### Modulation

AM, FM, $\phi$ M modulation frequency	10 mHz to 100 kHz
AM modulation depth	0% to 100%
FM frequency deviation	100 mHz to 17.5 MHz
$\phi$ M, PSK phase deviation	$-180^\circ$ to $+180^\circ$
FSK, PSK modulation frequency	0.1 mHz to 2 MHz
FSK frequency deviation	10 $\mu$ Hz to 500 kHz (sine: 35 MHz)

### Spectral purity (sinewave)

Harmonic distortion, $<3$ V ( $V_{pp}$ ), 20 Hz $\leq$ f $\leq$ 1 MHz	$<-65$ dBc
Nonharmonic distortion, 10 $\mu$ Hz $\leq$ f $\leq$ 5 MHz	typ. $-70$ dBc
SSB phase noise, 10 kHz offset from carrier, 10 MHz	$-118$ dBc (1 Hz)

### Signal characteristics

Square, duty cycle, $\leq$ 500 kHz	1% to 99% (selectable)
Square, duty cycle, 10 $\mu$ Hz to 50 MHz	50% (fixed)
Pulse period	70 ns to 9999 s
Pulse width	20 ns to 9999 s
Ramp/triangle, symmetry	0% to 100v
Exponential	rise or fall
Arbitrary rise time	$<10$ ns
Arbitrary loading time via USB	16 s (binary, 256k points)

### Gate/burst

Waveforms	sine, triangle, ramp, square, exponential, arbitrary
Gate settings	block end, sample & hold, burst
Number of cycles per burst	1 to 65535
Gate source	internal, external

### Sweep

Waveforms	sine, triangle, ramp, square, exponential, arbitrary
Type	linear, logarithmic
Sweep time	1 ms to 999 s
Marker	frequency marker

### Trigger

Source	manual, internal, external
Delay, setting range	0 ns or 150 ns to 9999 s
Internal trigger, repetition cycle	500 ns to 9901 s (2 MHz to 101 $\mu$ Hz)
Sync outputs	2

### General data

Display	5.4" active colour TFT, 320 $\times$ 240 pixels
USB host, USB device	Version 1.1
Additional memory	USB memory stick
Power supply	100 V to 240 V AC (autoranging), 50 Hz to 60 Hz
Power consumption	$<35$ VA
Operating temperature range	$+5^\circ\text{C}$ to $+45^\circ\text{C}$
Dimensions (W $\times$ H $\times$ D)	219 mm $\times$ 147 mm $\times$ 350 mm
Weight	6.2 kg

### Ordering information

#### Dual-Channel Arbitrary/Function Generator R&S® AM300

(including PC software R&S®AM300-K1) R&S®AM300 1147.1998.03

#### Recommended extras

Waveform Composer (software, licensed for 5 instruments)	R&S®AM300-K2	1147.2013.02
Rack Adapter	R&S®ZZA-300	1147.1281.00

[Contents Overview](#)
[Chapter Overview](#)
[Type Index](#)
[R&S Addresses](#)

## Baseband Fading Simulator R&amp;S® ABFS

## Saving costs through real-world fading tests

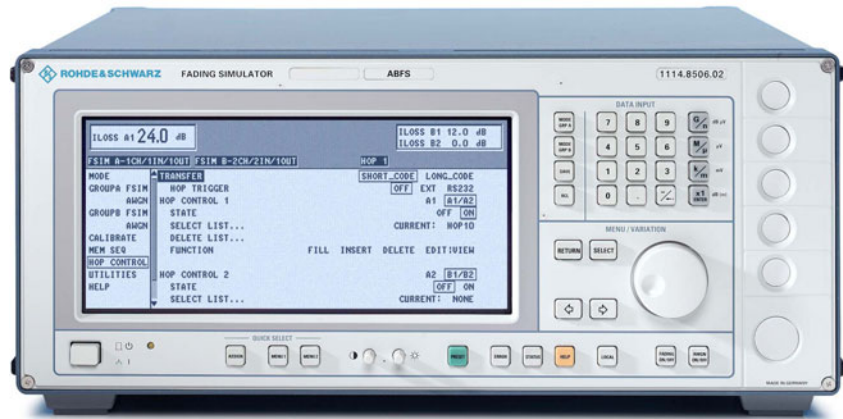

## Brief description

The characteristics of a radio channel may strongly impair signal transmission between a transmitter and in particular a moving receiver.

Baseband Fading Simulator R&S® ABFS generates signals which simulate real receive conditions in mobile applications. Thus, the response of receivers under real-world conditions can be checked already during development and QM acceptance testing. The simulation of fading signals at baseband level reduces costs.

Baseband Fading Simulator R&S® ABFS is suitable for universal mobile radio applications in research, development and production. It comprises all scenarios and statistical models for simulating sporadic fading as specified in the test regulations of mobile radio standards (e.g. GSM, IS-54/IS-136 or IS-95 CDMA).

The open concept of R&S® ABFS allows the simulation of radio channels of existing and future communication systems (e.g. mobile radio, broadcasting, flight telephone, WLL, or WLAN systems). R&S® ABFS can also simulate frequency hopping systems. The basic model of

R&S® ABFS comes with two independent channels for 6-path fading. The two channels can be interconnected as follows:

- ◆ Distribution of an input to two outputs (e.g. with different fading profiles). This feature makes it possible to simulate several antennas with different characteristics or frequency diversity methods
- ◆ Simulation of two inputs with individual profiles and addition at output. Cell change or superposition of interferers can be tested with this configuration
- ◆ Coupling of two channels so that a channel with 12 propagation paths is obtained

## Main features

- ◆ 2 fading channels (4 with option R&S® ABFS-B2)
- ◆ 12 propagation paths (24 with option R&S® ABFS-B2)
- ◆ Max. 12 propagation paths per channel
- ◆ Universal use in research, development and production
- ◆ Simulation of present and future communication systems thanks to open concept
- ◆ Receiver tests at I/Q level together with a baseband source

- ◆ Ease of operation
- ◆ High reliability

## Options

**Noise Generator R&S® ABFS-B1** adds a noise source to the output of the first channel so that noise can be simulated in the frequency band used. The noise generator can be switched on or off irrespective of the operating modes of the basic version.

**Second Fading Simulator**

**R&S® ABFS-B2** offers two extra channels with the same characteristics in addition to the two channels of the basic model.

**Second Noise Generator**

**R&S® ABFS-B3** represents an additional noise source for a further output. This second noise generator is either assigned to the second channel of the basic R&S® ABFS (with first noise generator R&S® ABFS-B1 for the first channel) or to the first channel of the second fading simulator R&S® ABFS-B2. Fading profiles of the Rayleigh, Rician, Pure Doppler, log-normal or Suzuki method can be assigned to each of the propagation paths irrespective of the selected circuit. In addition to the fading profiles mentioned, the following parameters can be defined for each propagation path:

## Baseband Fading Simulator R&amp;S® ABFS

- ◆ Path attenuation
- ◆ Delay time
- ◆ Doppler frequency or speed between transmitter and receiver
- ◆ Coupling to another channel

Many fading models (e.g. GSM Rural Urban, Typical Urban) have already been programmed in R&S® ABFS. The user can quickly recall these default settings and also modify the parameters.

### Enhanced fading functions for WCDMA 3GPP with option R&S® ABFSB49

R&S® ABFSB49 extends the functionality of the baseband fading simulator R&S® ABFS to include WCDMA 3GPP channel simulation. It adds three new modes to the fading simulator so that all scenarios defined in 3GPP Release 99 can be simulated:

- ◆ In fine delay mode, fading simulator resolution is increased to 1 ns with up to four paths being available
- ◆ In moving delay mode, two paths are simulated: for one path the delay remains constant, whereas for the other path the delay varies continuously
- ◆ In birth-death mode, there are two paths changing delay in steps in accordance with the 3GPP channel model

## Specifications in brief

You will find detailed and binding data on enclosed CD (./DATASHEET/ABFS.pdf) or top current on our web page: [www.rohde-schwarz.com](http://www.rohde-schwarz.com), search term: ABFS

Fading simulation	
Number of propagation paths and fading channels	1 channel with 12 paths or 2 channels with 6 paths each
Basic model with option R&S® ABFS-B2	2 channels with 12 paths each or 4 channels with 6 paths each
Insertion loss between input and output at 0 dB path attenuation	min. 9 dB
Path attenuation	0 dB to 50 dB
Path delay	0 µs to 1600 µs
Doppler shift, frequency range	0.1 Hz to 1600 Hz
Doppler shift, speed range, for example at $f_{RF} = 1$ GHz	$v_{min} = 0.1$ km/h, $v_{max} = 1724$ km/h
Rayleigh fading	
Pseudo noise interval	>372 h
Rice fading, power ratio	-30 dB to +30 dB
Rice fading, frequency ratio	-1 to +1
Lognormal fading, Suzuki fading	
Standard deviation, range	0 dB to 12 dB
Correlation	paths 1 to 6 with paths 7 to 12 of a channel (A or B)
Frequency hopping mode	RF can be stored in a list and quickly set via a serial interface
Setting time after frequency change during Rayleigh fading	<3.5 ms
Noise generator with options R&S® ABFS-B1 or R&S® ABFS-B3	
Amplitude distribution	Gaussian, statistically independent for I and Q
Crest factor	14 dB
Noise power level in relation to full-scale level, range	-17 dBfs to -50 dBfs
Insertion loss input/output	0 dB, 6 dB, 12 dB to 42 dB
Output spectrum	white noise
Bandwidth	depending on set system bandwidth
RF system bandwidth <sup>3)</sup>	bandwidth determining noise power
Setting range	10 kHz to 10 MHz

### Enhanced Fading Functions for WCDMA 3GPP R&S® ABFSB49

The enhanced fading functions for WCDMA 3GPP are only available for the R&S® ABFS standard fading simulator, not for the second fading simulator (option R&S® ABFS-B2).

Modes	Standard fading, fine delay, birth-death
Setting time after RF frequency change	6 ms
Fine delay mode	
RF bandwidth	4.8 MHz
Number of paths	4
Profiles	Rayleigh, pure Doppler
Moving delay mode	
RF bandwidth	4.8 MHz
Number of paths	2
Birth-death mode	
Number of paths	2
Profiles	pure Doppler
General data	
Memory for device settings	50
Remote control	IEC625 (IEEE488)
Power supply	90 V to 132 V (AC), 47 Hz to 440 Hz, 180 V to 265 V (AC), 47 Hz to 440 Hz, autoranging, max. 300 VA
Operating temperature range	0°C to 45°C
Dimensions (W × H × D)	435 mm × 192 mm × 460 mm
Weight	20 kg when unit is fully equipped

## Ordering information

Baseband Fading Simulator	R&S® ABFS	1114.8506.02
Accessories supplied	power cable, operating manual	
Options		
Noise Generator	R&S® ABFS-B1	1115.0009.02
Second Fading Simulator	R&S® ABFS-B2	1115.0309.02
Second Noise Generator	R&S® ABFS-B3	1115.0609.02
Fading for 3GPP	R&S® ABFSB49	1115.0909.02
Extras		
19" Rack Adapter	R&S® ZZA-94	0396.4905.00
Service Kit	R&S® SM-Z3	1085.2500.02
Trolley	R&S® ZZK-1	1014.0510.00
Transit Case	R&S® ZZK-944	1013.9366.00
Service Manual	R&S® ABFS	1114.8564.94